



Iluminación Profesional Catálogo-X 2019-2020

ÍNDICE NUMÉRICO

00-2902-*	9	06-1702-*	19	07-40922-*	64	22-2073-*	48	6-21701-*	24	D2-TC	114
00-2918-*	9	06-2012-*	19	07-40926-*	64	22-3002-*	34	6-21721-*	24	DIM-D1	114
00-2922-*	9	06-2283-*	17	07-4201-*	43	22-4224-*	28	6-26752-*	20	DX-2TC	106
03-4801-*	57	06-2489-*	17	07-6201-*	62	22-4506-*	28	6-26752-RGB	83	DX-2TC	106
04-4901-*	56	06-3108-*	25	07-6201-RGB	84	22-4712-*	28	6-26951-*	20	DX-3RGB	106
04-1202-*	2	06-3110-*	25	07-62024-*	61	22-6136-*	35	6-26957-*	20	DX-5	106
04-1215-*	2	06-3117-*	25	07-62100-*	61	22-7133-*	49	6-27051-*	21	DX-7TC	106
05-0010-*	80	06-3125-*	25	07-6301-*	62	22-7161-*	47	6-28151-*	21	DX-8RGBW	106
05-0020-*	80	06-3155-*	16	07-6301-RGB	84	22-8401-*	8	64-2706-*	6	E35-RGB	114
05-0030-*	80	06-3198-*	16	07-6401-*	62	22-8402-*	8	6-51112-*	30	FB-43282-*	93
05-0050-*	80	06-3199-*	16	07-6401-RGB	84	22-8404-*	8	6-52112-*	30	FB-72282-*	93
05-0502-RGB	86	06-3254-*	16	07-7301-*	63	22-9036-*	22	6-53112-*	30	FC-43286-*	98
05-0720-*	52	06-4401-*	18	07-9201-*	60	22-9051-*	46	66-3407-*	17	FE-43285-*	94
05-0901-RGB	83	06-4402-*	18	08-0360-*	39	26-1340-50	36	7-06210-*	62	FE-43287-*	94
05-0912-*	57	06-4406-*	27	08-1273-*	44	26-2601-*	37	77-0306-*	72	FE-72287-*	95
05-1000-*	51	06-4512-*	27	08-1901-*	53	26-6640-50	37	77-0391-*	72	FS-0036-RGB	97
05-1016-*	51	06-9033-10	22	08-2201-*	53	27-1621-*	50	77-0393-RGB	87	FS-0036-RGB	97
05-1018-*	51	06-9034-*	22	08-2203-*	53	27-4001-40	89	77-1030-*	69	FS-1036-RGB	98
05-1751-*	54	06-9035-*	22	08-3013-10	13	28-1340-50	36	77-1035-*	69	FS-27352-*	99
05-1841-*	47	06-9129-10	12	08-7401-*	39	28-6640-50	37	77-1036-*	69	FS-43285-*	94
05-2071-*	48	06-9130-10	12	08-7501-*	39	28-6675-50	36	77-4703-*	71	FS-48356-TC	96
05-2072-*	48	06-9131-10	12	08-8301-*	115	30-0412-*	7	77-4703-RGB	87	FS-48356-TC	96
05-2202-*	57	06-9224-10	13	08-8401-*	115	35-1005-*	4	80-0923-*	2	FS-96555-RGB	97
05-2509-*	54	06-9229-10	12	08-8501-*	115	35-2703-*	5	80-0924-*	2	FS-96555-	97
05-2701-*	54	06-9285-10	13	08-9002-*	41	45-1004-*	4	80-1015-*	7	FV-48110-*	99
05-2799-*	40	06-9442-10	13	08-9243-*	42	45-1204-*	5	80-1112-*	7	K1-110	109
05-2800-*	40	06-9703-10	14	08-9244-*	42	45-2604-*	6	80-1203-*	5	K2-110	109
05-2801-*	40	06-9703-D	14	08-9245-*	42	45-2704-*	6	80-1205-*	3	PS-12025	101
05-2805-*	40	06-9703-I	14	10-1071-*	76	5-21101-RGB	85	80-1210-*	7	PS-12050	101
05-2806-*	40	06-9703-TD	14	10-1932-*	77	5-21201-RGB	85	80-1603-RGB	3	PS-12100	101
05-2807-*	40	06-9703-TI	14	10-2091-*	75	5-21301-RGB	85	80-2006-*	3	PS-12150	102
05-3505-*	56	07-0061-*	58	10-2704-*	74	5-25100-*	81	80-2007-*	3	PS-12250	102
05-5581-*	50	07-0062-*	58	10-9107-*	76	5-25250-*	81	80-2225-*	3	PS-24050	101
05-7001-*	43	07-0301-*	60	11-1735-*	34	5-25400-*	81	80-2503-*	2	PS-24100	101
05-7021-*	71	07-0301-RGB	83	11-2101-*	33	55-1933-*	77	80-3002-*	7	PS-24150	102
05-7021-RGB	87	07-0401-*	60	11-2409-*	33	55-2091-*	75	81-0925-*	2	PS-24250	102
05-7131-*	49	07-0455-*	71	11-2925-*	34	55-2301-*	74	86-1702-KIT	19	PS-24400	102
05-7132-*	49	07-07300-*	66	11-3001-*	33	55-2704-*	74	90-2501-RGB	86	REC-R4-5A	107
05-7302-*	50	07-07601-*	66	11-5009-*	33	55-9107-*	76	90-3001-*	79	REC-R4-CC	107
05-7491-*	46	07-1091-*	60	15-0050-65	91	60-1007-*	4	90-3001-RGB	86	REP-3050-T	110
05-7492-*	46	07-1276-*	44	15-0100-65	91	60-1011-*	4	90-3201-*	79	REP-3053-R	110
05-7493-*	47	07-1280-*	43	15-0150-65	91	6-0406-*	26	90-3202-*	79	REP-3060	110
05-7494-*	47	07-1701-*	59	15-0180-65	91	6-0509-*	26	97-06300-*	66	REP-3063	110
05-8054-*	46	07-1701-RGB	83	20-1002-60	85	6-0718-*	26	97-06601-*	66	REP-3070	110
05-8107-*	52	07-1703-*	59	20-3110-50	90	6-12454-*	29	ACT-0803	104	TR/50W/S	103
05-8108-*	52	07-1707-*	70	20-7100-50	90	6-12554-*	29	ACT-0873	104	TRA-12100	103
05-9001-*	41	07-2702-*	43	22-0128-*	31	6-12654-*	29	ACT-140350	104	TRA-12200	103
05-9105-*	56	07-2721-*	58	22-0136-*	31	6-21300-*	23	ACT-150350F	104	TRA-1245	103
05-9205-*	56	07-30011-*	65	22-0210-*	89	6-21301-*	23	AP-1616	100	TRA-24100	103
05-9801-*	51	07-30012-*	65	22-0218-*	89	6-21401-*	24	AP-2507	100	TRA-24200	103
06-0406-*	27	07-30016-*	65	22-0506-*	28	6-21421-*	24	AP-2811	100	TRA-2430	103
06-0512-*	27	07-30100-*	61	22-0712-*	28	6-21501-*	24	CM-1	113	TRA-2460	103
06-0718-*	27	07-4031-*	70	22-1224-*	28	6-21521-*	24	CM-2	113	WIFI-106	111
06-1070-*	26	07-4051-*	70	22-2011-*	35	6-21601-*	24	CM-6	113		
06-1090-*	26	07-40921-*	64	22-2060-*	35	6-21621-*	24	D2-TC	114		

ÍNDICE REFERENCIAL

Focos LED	1 - 9
Gypsum	10 - 14
Downlights	15 - 31
Profesional	32 - 37
Cortesía	38 - 44
Outdoor Pared	45 - 54
Outdoor Piso	55 - 66
Subacuáticas	67 - 72
Balizas	73 - 77
Reflectores	78 - 81
Sistemas RGB	82 - 87
Industrial	88 - 90
Urbana	91
Tiras LED	92 - 100
Accesorios	101 - 104
Astro LTECH	105 - 114
Productos Nuevos	115

GLOSARIO DE ACABADOS Y NOMENCLATURAS

TEMPERATURA DE COLOR

- WW Luz Cálida (2800-3300K)

- NW Luz Neutra (4000-4500K)

- DW Luz de Día (5000K)

- CW Luz Fría (6000-6500K)

- RGB Cambio de color



Luz Cálida: (Temperaturas de color entre 2800°K y 3500°K). Equivale a la luz que producían las bombillas incandescentes y los focos halógenos. Es recomendable en tiendas de ropa, fruterías, panaderías, charcuterías y carnicerías (estas 2 últimas es más habitual incluso una iluminación de tono rosa). En el caso de viviendas, se recomienda su instalación en estancias como el salón y los dormitorios.

Luz Neutra: (Temperaturas de color entre 3800°K y 4500°K) dicen los expertos que es la luz más natural. Se puede instalar en cualquier entorno que no requiera del matiz específico que puedan aportar las otras 2 categorías.

Luz Fría: (Temperaturas de color de más de 5000°K). Equivale a la luz de un día muy soleado o nublado. Una de las ventajas de la luz fría es que a la misma intensidad aporta una mayor cantidad de lúmenes lo que genera una percepción mayor de luminosidad. Es una luz muy recomendada para pescaderías y joyerías. Respecto a viviendas, es habitual encontrarlo en cocinas y baños. Aunque los expertos en maquillaje recomiendan siempre luces cálidas ya que tienen la ventaja de aportar una mejor gama cromática.

NIVEL DE PROTECCIÓN

- IP 44** La lámpara está protegida contra objetos sólidos mayores de 1mm y contra proyecciones de agua en todas direcciones.
- IP 54** La lámpara está protegida contra el polvo y contra proyecciones de agua en todas direcciones.
- IP 55** La lámpara está protegida contra el polvo y contra chorros de agua en todas direcciones.
- IP 65** La lámpara está protegida contra el polvo y contra fuertes chorros de agua en todas direcciones.
- IP 66** La lámpara está protegida contra el polvo y contra las pulverizaciones de agua con una presión de 1 bar a 3m.
- IP 67** La lámpara está completamente protegida del polvo y contra los efectos de la inmersión en cortos períodos de tiempo.
- IP 68** La lámpara está completamente protegida del polvo y contra los efectos de la inmersión prolongada en agua profunda.

ACABADOS

- 01 Blanco
- 02 Satinado
- 03 Gris
- 04 Grafito
- 05 Bronce Rust
- 06 Cromo
- 07 Negro
- 08 Acero
- 10 Yeso

Nuestras luminarias cuentan con algunas de las mejores marcas de LED en el mercado:



*Nota: El color de la fotografía puede variar de acuerdo a la original debido a limitaciones inherentes al proceso fotográfico.

** El flujo luminoso está en Lúmenes.

FOCOS LED

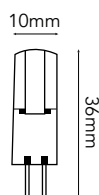

04-1202-*

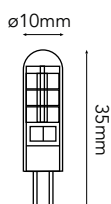

04-1215-*

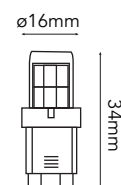

80-0923-*

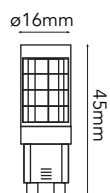

80-0924-*

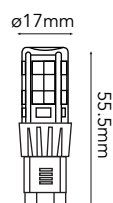

81-0925-*

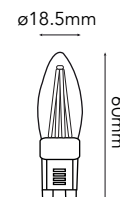

80-2503-*



Modelo	LED Watt	Flujo Luminoso	Tipo LED	Base	Ángulo Apertura	CRI	CCT	Voltaje	IP	Material
04-1202-*	1.5W	180	COB	G4	360°	>80	3000K	12V AC/DC	20	Tapa de Gel
04-1215-*	1W	120	SMD	G4	360°	>80	3000K	12V AC/DC	20	Cristal
80-0923-*	2.5W	220	SMD	G9	360°	>80	3000K	100-130V AC	20	Cerámica + PC
80-0924-*	3.5W	380	SMD	G9	350°	>80	3000K / 4000K	100-130V AC	20	Cerámica + PC
81-0925-*	4W	500	SMD	G9	350°	>80	3000K	100-130V AC	20	Cerámica + PC
80-2503-*	2.5W	260	Filamento	G9	350°	>80	3000K	100-130V	20	Cerámica + Cristal



FOCOS LED

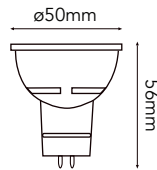

80-1205-*

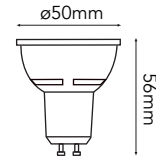

80-2006-* | 80-2007-*

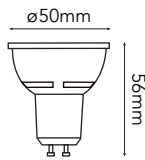

80-2225-*

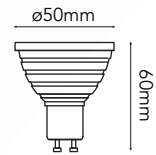

80-1603-RGB

Modelo	LED Watt	Flujo Luminoso	Tipo LED	Base	Ángulo Apertura	CRI	CCT	Voltaje	IP	Material
80-1205-*	5W	400	SMD	GU5.3	38°	>80	3000K / 4000K	90-130V	20	Plástico + Cristal
80-2006-*	6.5W	560	SMD	GU10	38°	>80	3000K / 4000K	100-240V	20	Plástico + Cristal
80-2007-*	6.5W	560	SMD	GU10	38°	>80	3000K / 4000K	90-130V	20	Plástico + Cristal
80-2225-*	5W	400	SMD	GU10	38°	>80	3000K / 4000K / 6500K	100-240V	20	Plástico + Aluminio
80-1603-RGB	3W	40	COB	GU10	35°	-	RGB	100-120V	20	Aluminio

FOCOS LED

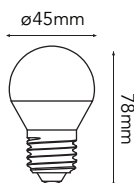

45-1004-*

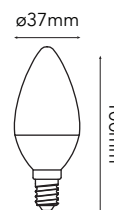

35-1005-*

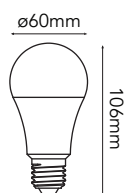

60-1007-*

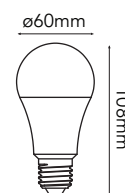

60-1011-*

Modelo	LED Watt	Flujo Luminoso	Tipo LED	Base	Ángulo Apertura	CRI	CCT	Voltaje	IP	Material
45-1004-*	4.5W	400	SMD	E26	180°	>80	3000K / 4000K / 6000K	110-130V	20	Aluminio + PC
35-1005-*	4.5W	340	SMD	E12	180°	>80	3000K / 4000K	110-130V	20	Aluminio + PC
60-1007-*	7W	560	SMD	E26	270°	>80	3000K / 4000K / 6000K	110-130V	20	Aluminio + PC
60-1011-*	11W	1050	SMD	E26	270°	>80	3000K / 4000K / 6000K	110-130V	20	Aluminio + PC

FOCOS LED

FOCOS LED



80-1203-*



35-2703-*



45-1204-*

Modelo	LED Watt	Flujo Luminoso	Tipo LED	Base	Ángulo Apertura	CRI	CCT	Voltaje	IP	Material
80-1203-*	2.2W	260	Filamento	E12	350°	>80	3000K	90-130V	20	Aluminio + Cristal
35-2703-*	5W	600	Filamento	E12	360°	>80	2700K	110-130V	20	Aluminio + Cristal
45-1204-*	5W	600	Filamento	E12	360°	>80	2700K	110-130V	20	Aluminio + Cristal

FOCOS LED



45-2604-*



45-2704-*



64-2706-*



Modelo	LED Watt	Flujo Luminoso	Tipo LED	Base	Ángulo Apertura	CRI	CCT	Voltaje	IP	Material
45-2604-*	5W	600	Filamento	E26	360°	>80	2700K	110-130V	20	Aluminio + Cristal
45-2704-*	3W	360	Filamento	E26	360°	>80	2700K	110-130V	20	Aluminio + PC
64-2706-*	5W	600	Filamento	E26	360°	>80	2700K	110-130V	20	Aluminio + PC 

FOCOS LED

FOCOS LED

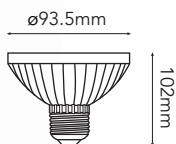

80-3002-*

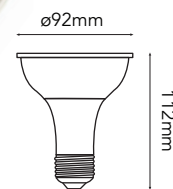

30-0412-*

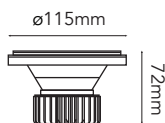

80-1112-* | 80-1112-D 

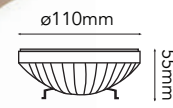

80-1015-*

Modelo	LED Watt	Flujo Luminoso	Tipo LED	Base	Tipo de Foco	Ángulo	CRI	CCT	Voltaje	IP	Material
80-3002-*	10W	800	SMD	E26	PAR30	45°	>80	3000K / 4000K	85-265V	20	Aluminio + PC
30-0412-*	12W	960	SMD	E26	PAR30	45°	>80	3000K / 4000K	85-265V	20	Aluminio + PC
80-1112-*	12W	960	COB	AR111	AR111	20°	>80	3000K / 4000K	90-240V	20	Aluminio
80-1015-*	13W	1200	SMD	AR111	AR111	24°	>80	4000K	12V, AC/DC	20	Aluminio + PC

INTELE-TUBE

FOCOS LED

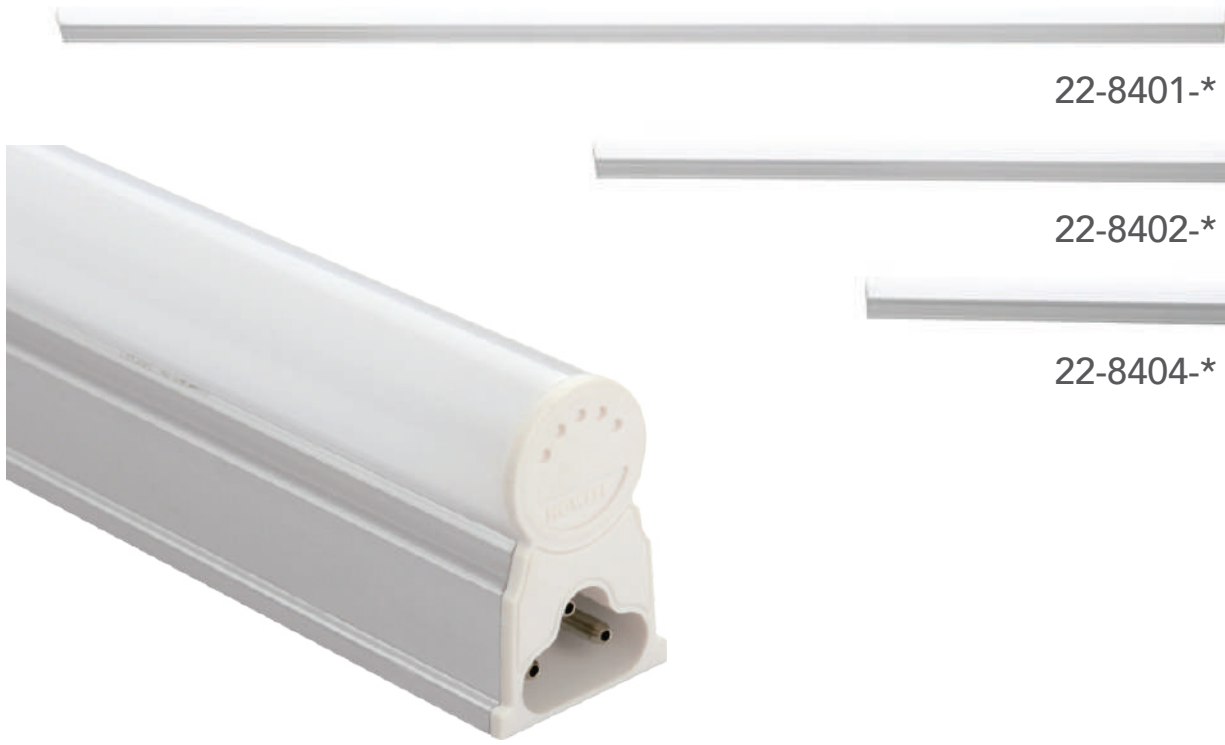

22-8401-*

22-8402-*

22-8404-*

22-8401-*

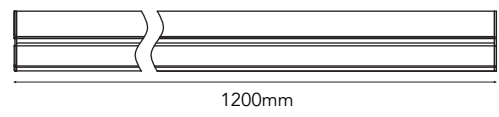

1200mm

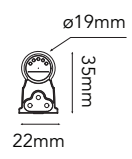

22-8402-*



600mm

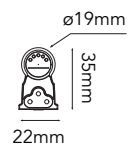

22-8404-*

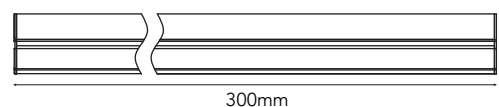

300mm

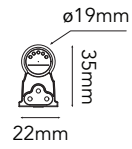

Modelo	LED Watt	Flujo Luminoso	Tipo LED	Tubo	Ángulo Apertura	CRI	CCT	Voltaje	IP	Material
22-8401-*	18W	1980	SMD	T5	120°	>80	3000K / 4000K	100-240V	20	Aluminio +PC
22-8402-*	9W	1100	SMD	T5	120°	>80	3000K / 4000K	100-240V	20	Aluminio +PC
22-8404-*	5W	450	SMD	T5	120°	>80	4000K	100-240V	20	Aluminio +PC

TUBO LED

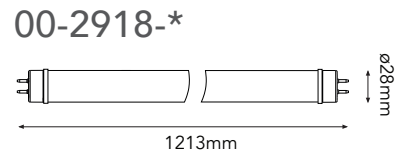
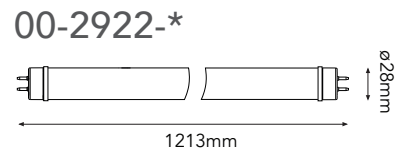
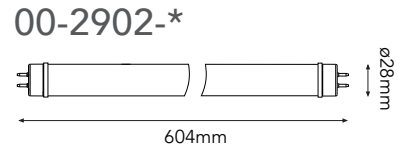

Características Especiales:

- *Cubierta de cristal 100% de aislamiento, más seguro, aspecto similar al tubo tradicional.
- *Aislamiento total entre los dos extremos - Una instalación más segura.
- *LED SMD 2835 - Este tipo de LED es más delgado, tiene una mejor disipación del calor, cuenta con un ángulo más amplio y es más brillante.
- *Última tecnología en diseño de driver. Alta eficiencia, voltaje de entrada universal, alto factor de potencia, menos calor, por tanto, menor desgaste y mejor tiempo de vida.
- *Estructura con diseño único para un fácil montaje e instalación.

Modelo	LED Watt	Flujo Luminoso	Tipo LED	Tubo	Ángulo Apertura	CRI	CCT	Voltaje	IP	Material
00-2902-*	10W	1000	SMD 2835	T8	240°	>80	3000K / 4100K/ 6000K	100-240V	20	Cristal+PET
00-2922-*	18W	1800	SMD 2835	T8	240°	>80	3000K / 4100K/ 6000K	100-240V	20	Cristal+PET
00-2918-41	18W	1800	SMD 2835	T8	240°	>80	4100K	100-277V	20	Cristal+PET

GYPSUM



GYPSUM

Luminarios Gypsum. Hechos a base de yeso, especialmente diseñados para colocar en plafones de tablaroca. Con un efecto final invisible que enriquece la atmósfera de cualquier habitación.



GYPSUM

¡FÁCIL INSTALACIÓN!

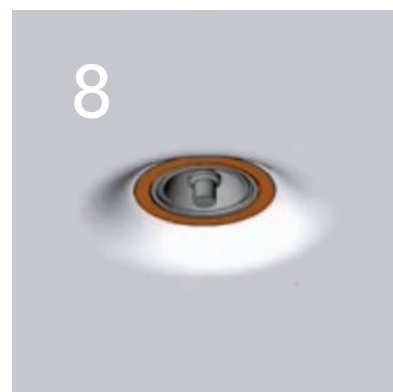
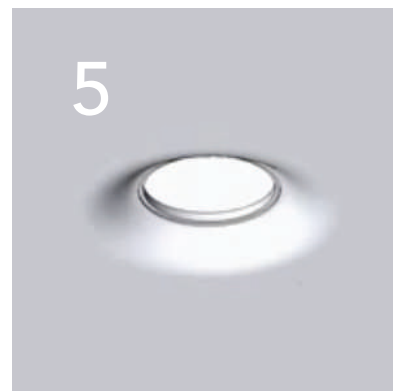
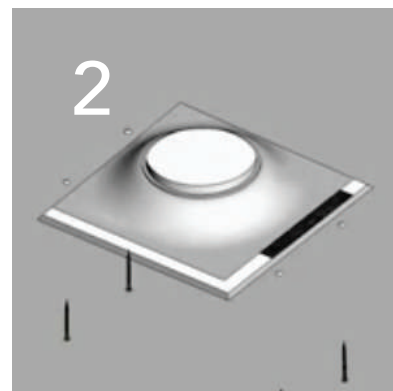

GYPSUM

GYPSUM

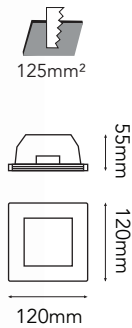

06-9129-10

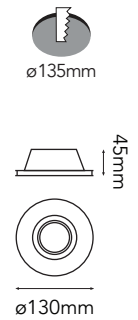

06-9130-10

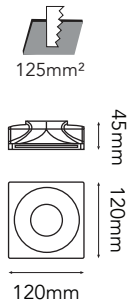

06-9131-10

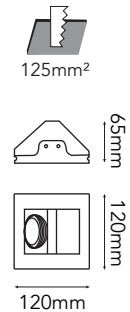

06-9229-10

NOTA: Focos no incluidos, Soquet incluido.

Modelo	Watts	Base	Voltaje	IP	Material
06-9129-10	Máx. 35W	GU10	127V	20	Yeso
06-9130-10	Máx. 35W	GU10	127V	20	Yeso
06-9131-10	Máx. 35W	GU10	127V	20	Yeso
06-9229-10	Máx. 35W	GU10	127V	20	Yeso

GYPSUM

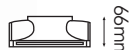

06-9224-10

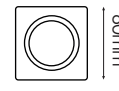
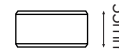

06-9285-10

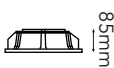

06-9442-10



08-3013-10

NOTA: Focos no incluidos, Soquet incluido.

Modelo	Watts	Base	Voltaje	IP	Material
06-9224-10	Máx. 35W	GU10	127V	20	Yeso
06-9285-10	Máx. 35W	GU10	127V	20	Yeso
06-9442-10	Máx. 50W	AR111	127V	20	Yeso
08-3013-10	Máx. 50W	GU10	127V	20	Yeso

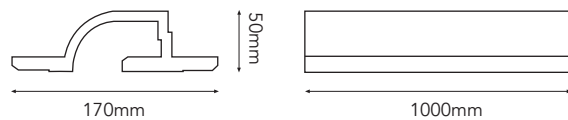

06-9703-10

*Para plafón de tablaroca 12mm

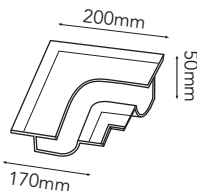

06-9703-D

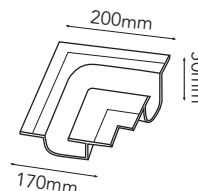

06-9703-I

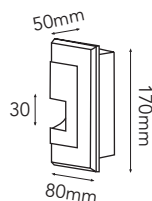

06-9703-TD

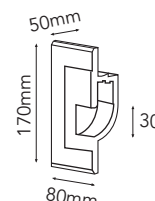

06-9703-TI

NOTA: Focos no incluidos, Soquet incluido.

Modelo	Base	IP	Material
06-9703-10	Para tira de LED	20	Yeso
06-9703-D	Para tira de LED	20	Yeso
06-9703-I	Para tira de LED	20	Yeso
06-9703-TD	Para tira de LED	20	Yeso
06-9703-TI	Para tira de LED	20	Yeso

DOWNLIGHTS



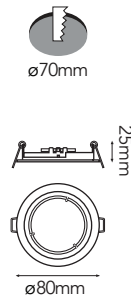

06-3155-*

-01 Blanco -02 Satinado -07 Negro

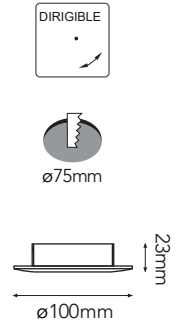

06-3254-*

-01 Blanco -02 Satinado -07 Negro



06-3198-*

-01 Blanco -07 Negro

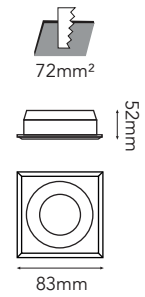

06-3199-*

-01 Blanco -07 Negro

NOTA: Focos no incluidos, Soquet incluido.

Modelo	Watts	Base	Voltaje	IP	Material
06-3155-*	Máx. 50W	GU10	127V	20	Aluminio
06-3254-*	Máx. 50W	GU10	127V	20	Aluminio
06-3198-*	Máx. 50W	GU10	127V	20	Aluminio
06-3199-*	Máx. 50W	GU10	127V	20	Aluminio

BASIC

DOWNLIGHTS

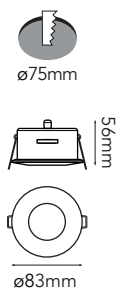

66-3407-*

-01 Blanco -06 Cromo

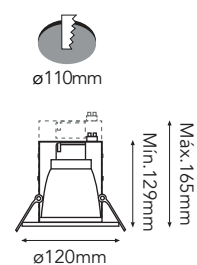

06-2283-*

-01 Blanco -02 Satinado

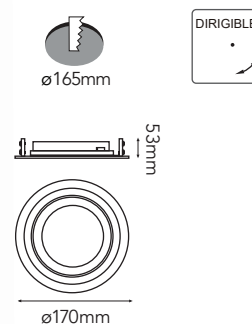

06-2489-*

-01 Blanco

NOTA: Focos no incluidos, Soquet incluido.

Modelo	LED Watt	Base	Voltaje	IP	Material
66-3407-*	Máx. 50W	GU10	127V	65	Alum + Aleación de Zinc
06-2283-*	Máx. 50W	E26	127V	20	Aluminio
06-2489-*	Máx. 100W	G53	127V	20	Aluminio

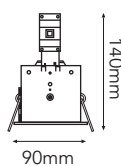

06-4401-*

- 01 Blanco
- 03 Gris

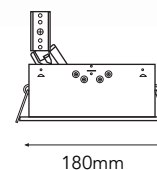

06-4402-*

- 03 Gris

NOTA: Focos no incluidos, Soquet incluido.

Modelo	Watts	Base	Voltaje	IP	Material
06-4401-*	Máx. 50W	GU10	120V	20	Aluminio
06-4402-*	Máx. 50W	GU5.3	12V CA	20	Aluminio + Acero

CORAL | QUARK

DOWNLIGHTS



86-1702-KIT-*

-02 Satinado

*Incluye driver



ø30mm

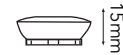

15mm

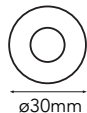

ø30mm



15mm

06-1702-*

-02 Satinado

*Requiere driver



+/-60°

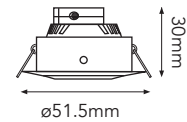

ø51.5mm

06-2012-*

-01 Blanco -02 Satinado

Modelo	LED Watt	Flujo Luminoso	Tipo LED	Ángulo Apertura	CRI	CCT	Voltaje	IP	Material
86-1702-KIT-*	3x1W	3x68	CREE SMD	50°	>80	3000K / 4000K	127V	20	PVC
06-1702-*	1W	68	CREE SMD	50°	>80	3000K	350mA	20	Cuerpo PVC
06-2012-*	2.2W	145	CREE SMD	40°	>80	3000K / 4000K	127V	20	Aluminio



6-26752-*

-01 Blanco

"Versiones Dimeables"
6-26752-30D / 6-26752-40D

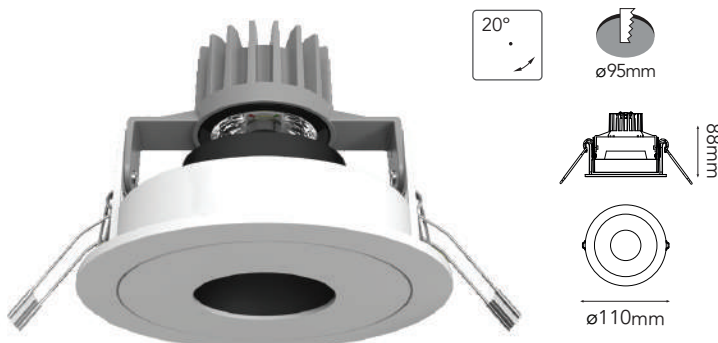

6-26951-*

-01 Blanco



6-26957-*

-01 Blanco

"Versiones Dimeables"
6-26957-30D / 6-26957-40D



Modelo	LED Watt	Flujo Luminoso	Tipo LED	Ángulo Apertura	CRI	CCT	Voltaje	IP	Material
6-26752-*	9W	600	COB EPISTAR	38°	>80	3000K / 4500K	100-240V	20	Aluminio
6-26951-*	9W	380	COB EPISTAR	25°	>80	3000K	90-130V	20	Aluminio
6-26957-*	9W	698	COB EPISTAR	35°	>80	3000K / 4000K	110-240V	20	Aluminio

SKY

DOWNLIGHTS

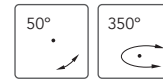
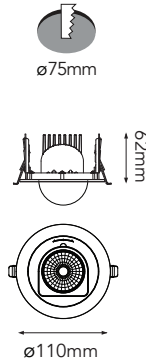

6-27051-*

-01 Blanco

"Versiones Dimeables" 
6-27051-30D | 6-27051-40D

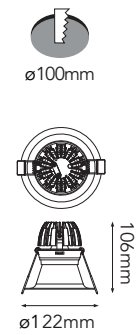

6-28151-*

"Versiones Dimeables" 
6-28051-30D | 6-28051-40D

Modelo	LED Watt	Flujo Luminoso	Tipo LED	Ángulo Apertura	CRI	CCT	Voltaje	IP	Material
6-27051-*	9W	698	COB EPISTAR	18°	>80	3000K	100-240V	20	Aluminio
6-28151-*	9W	600	COB EPISTAR	25°	>80	3000K / 4000K	90-240V	20	Aluminio



06-9033-10

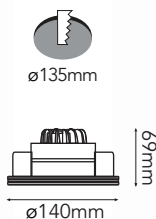

06-9034-*

-01 Blanco

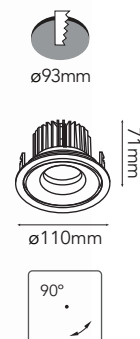

06-9035-*

-01 Blanco

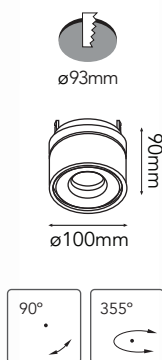

22-9036-*

-01 Blanco

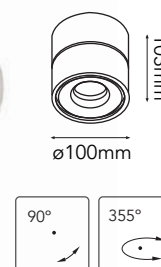

Modelo	LED Watt	Flujo Luminoso	Tipo LED	Ángulo Apertura	CRI	CCT	Voltaje	IP	Material
06-9033-10	11W	880	CREE PHILIPS	38°	>80	3000K	90-130V	20	Yeso
06-9034-*	13W	1040	CREE PHILIPS	38°	>80	3000K	120V	20	Aluminio
06-9035-*	13W	1040	CREE PHILIPS	38°	>80	3000K	90-130V	20	Aluminio
22-9036-WW	13W	856	CREE PHILIPS	38°	>80	3000K	120V	20	Aluminio

CAMALEÓN

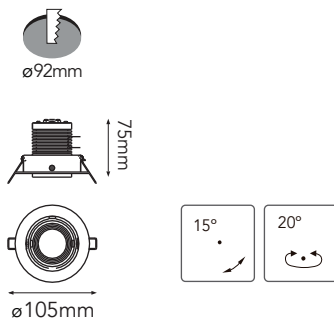

6-21300-* | 6-21300-D 

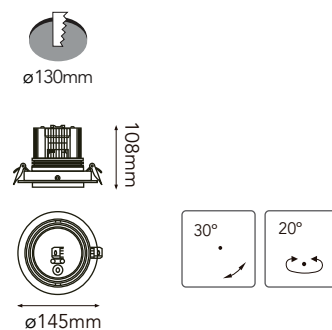

6-21301-*

Modelo	LED Watt	Flujo Luminoso	Tipo LED	Ángulo Apertura	CRI	CCT	Voltaje	IP	Material
6-21300-*	13W	890	SMD CREE	30°	>80	3000K / 4000K	127V	20	Aluminio
6-21301-*	28W	1800	SMD CREE	24°	>80	3000K / 4000K	127V	20	Aluminio

CALYPSO

DOWNLIGHTS



6-21701-* | 6-21721-* 



6-21601-* | 6-21621-* 



6-21501-* | 6-21521-* 



6-21401-* | 6-21421-* 

Modelo	LED Watt	Flujo Luminoso	Tipo LED	Ángulo Apertura	CRI	CCT	Voltaje	IP	Material
6-21701-* 6-21721-*	7W	550	SMD	90°	>80	3000K / 4000K	100-240V	20	Aluminio
6-21601-* 6-21621-*	12W	950	SMD	90°	>80	3000K / 4000K	100-240V	20	Aluminio
6-21501-* 6-21521-*	17W	1430	SMD	90°	>80	3000K / 4000K	100-240V	20	Aluminio
6-21401-* 6-21421-*	20W	1650	SMD	90°	>80	3000K / 4000K	100-240V	20	Aluminio

NOVA II

DOWNLIGHTS



06-3108-*



06-3110-*



06-3117-*



06-3125-*

Modelo	LED Watt	Flujo Luminoso	Tipo LED	Ángulo Apertura	CRI	CCT	Voltaje	IP	Material
06-3108-*	8W	680	SMD	90°	>80	3000K / 4000K	100-277V	20 / 44	Aluminio + Tapa plástica
06-3110-*	12W	1050	SMD	90°	>80	3000K / 4000K	100-277V	20 / 44	Aluminio + Tapa plástica
06-3117-*	17W	1670	SMD	90°	>80	4000K	100-277V	20 / 44	Aluminio + Tapa plástica
06-3125-*	25W	2230	SMD	90°	>80	4000K	100-277V	20 / 44	Aluminio + Tapa plástica

MELODY

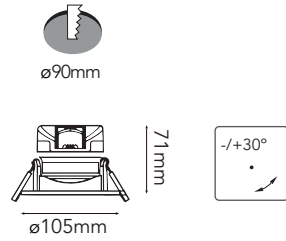

06-1090-*

-01 Blanco

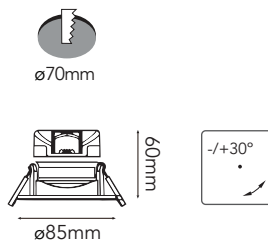

06-1070-*

-01 Blanco

Modelo	LED Watt	Flujo Luminoso	Tipo LED	Ángulo Apertura	CRI	CCT	Voltaje	IP	Material
06-1090-*	10W	950	SMD	36°	>80	3000K / 4000K	100-277V	20	Plástico + Alum
06-1070-*	7W	600	SMD	36°	>80	3000K / 4000K	100-277V	20	Plástico + Alum

EQUINOX - EMPOTRADOS

DOWNLIGHTS

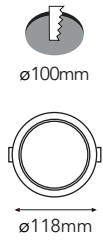

06-0406-*

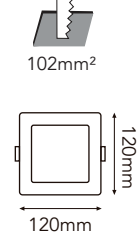

06-4406-*



06-0512-*

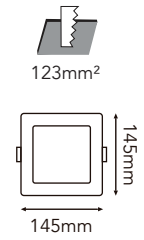

06-4512-*



06-0718-*

Modelo	LED Watt	Flujo Luminoso	Tipo LED	Ángulo Apertura	CRI	CCT	Voltaje	IP	Material
06-0406-*	6W	480	SMD	120°	>80	3000K / 4000K	90-240V	20	ABS + PMMA
06-4406-*	6W	480	SMD	120°	>80	3000K / 4000K	90-240V	20	ABS + PMMA
06-0512-*	12W	1000	SMD	120°	>80	3000K / 4000K	90-240V	20	ABS + PMMA
06-4512-*	12W	1000	SMD	120°	>80	3000K / 4000K	90-240V	20	ABS + PMMA
06-0718-*	18W	1584	SMD	120°	>80	3000K / 4000K	90-240V	20	ABS + PMMA



22-0506-*

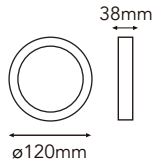

22-4506-*

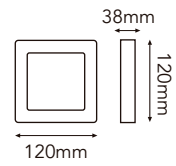

22-0712-*

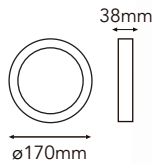

22-4712-*

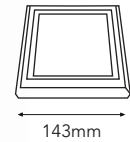

22-1224-*

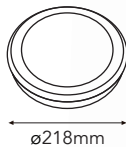

22-4224-*

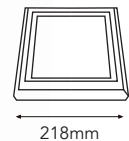

NOTA: Sistema de fijación a techo incluido.

Modelo	LED Watt	Flujo Luminoso	Tipo LED	Ángulo Apertura	CRI	CCT	Voltaje	IP	Material
22-0506-*	6W	480	SMD	120°	>80	3000K / 4000K	100-240V	20	Aluminio + PMMA
22-4506-*	6W	480	SMD	120°	>80	3000K / 4000K	100-240V	20	Aluminio + PMMA
22-0712-*	12W	1050	SMD	120°	>80	3000K / 4000K	100-240V	20	Aluminio + PMMA
22-4712-*	12W	1050	SMD	120°	>80	3000K / 4000K	100-240V	20	Aluminio + PMMA
22-1224-*	24W	1670	SMD	120°	>80	3000K / 4000K	100-240V	20	Aluminio + PMMA
22-4224-*	24W	1670	SMD	120°	>80	3000K / 4000K	100-240V	20	Aluminio + PMMA

APOLO

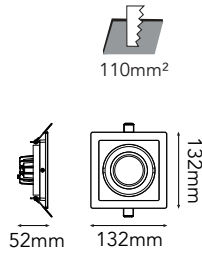

6-12454-* 

-01 Blanco -07 Negro

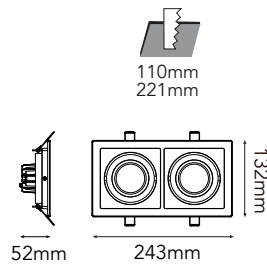

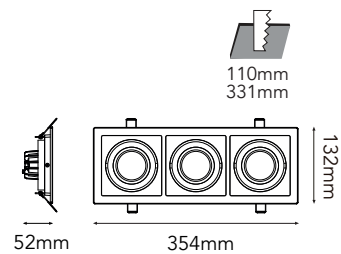

6-12554-* 

-01 Blanco -07 Negro



6-12654-*

-01 Blanco -07 Negro

Modelo	LED Watt	Flujo Luminoso	Tipo LED	Ángulo Apertura	CRI	CCT	Voltaje	IP	Material	
6-12454-*	9W	600	COB	24°	>80	3000K / 4000K	90-130V	20	Aluminio	
6-12554-*	18W	1200	COB	24°	>80	3000K / 4000K	90-130V	20	Aluminio	
6-12654-*	27W	1800	COB	24°	>80	3000K / 4000K	90-130V	20	Aluminio	



6-51112-*

-01 Blanco -07 Negro



165mm²

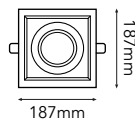

187mm



6-52112-*

-01 Blanco -07 Negro



165mm
315mm

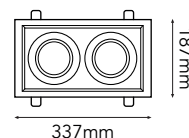

337mm



6-53112-*

-01 Blanco -07 Negro



165mm
465mm

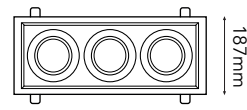

487mm

NOTA: Versión dimeable disponible. Consulte a su distribuidor autorizado.

Modelo	LED Watt	Flujo Luminoso	Tipo LED	Ángulo Apertura	CRI	CCT	Voltaje	IP	Material
6-51112-*	12W	960	COB	24°	>80	3000K / 4000K	90-240V	20	Aluminio + PMMA
6-52112-*	2x12W	1920	COB	24°	>80	3000K / 4000K	90-240V	20	Aluminio + PMMA
6-53112-*	3x12W	2880	COB	24°	>80	3000K / 4000K	90-240V	20	Aluminio + PMMA

PERSEIDA

DOWNLIGHTS

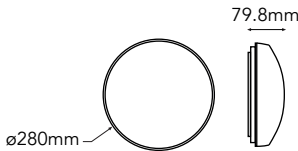

22-0128-*

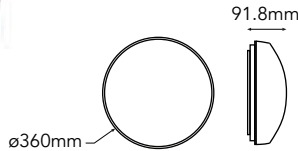

22-0136-*

Modelo	LED Watt	Flujo Luminoso	Tipo LED	Ángulo Apertura	CRI	CCT	Voltaje	IP	Material
22-0128-*	12W	1020	SMD	120°	>80	4000K	100-277V	20	Aluminio + Plástico
22-0136-*	18W	1530	SMD	120°	>80	4000K	100-277V	20	Aluminio + Plástico

PROFESIONAL



HÉRCULES

PROFESIONAL



11-5009-*

-01 Blanco -07 Negro



11-2409-*

-01 Blanco -07 Negro



11-2101-*

-01 Blanco -07 Negro



11-3001-*

-01 Blanco -07 Negro

NOTA: Driver incluido.

Modelo	LED Watt	Flujo Luminoso	Tipo LED	Base	Ángulo Apertura	CRI	CCT	Voltaje	IP	Material
11-5009-*	9W	630	COB	-	24°	>80	3000K / 4000K	100-240V	40	Aluminio
11-2409-*	-	-	-	GU10	-	-	-	100-240V	20	Aluminio
11-2101-*	21W	1510	COB CREE	-	25°	>80	3000K / 4000K	100-240V	20	Aluminio
11-3001-*	28W	1830	COB CREE	-	24°	>80	3000K / 4000K	100-240V	20	Aluminio

HÉRCULES II

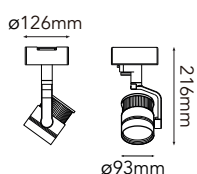

22-3002-*

-01 Blanco



Ángulo Ajustable
10° a 60°

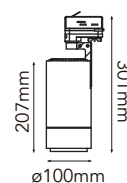

11-1735-*

-01 Blanco -07 Negro

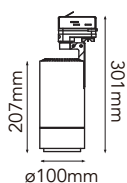

11-2925-*

-01 Blanco -07 Negro

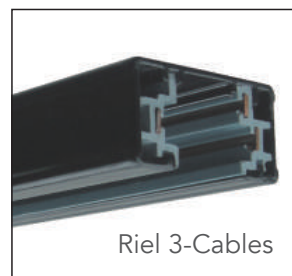

Riel 3-Cables

Nota: Todos nuestros luminarios a riel deben ser instalados usando un riel de 3 cables.

NOTA: Driver incluido.

Modelo	LED Watt	Flujo Luminoso	Tipo LED	Ángulo Apertura	CRI	CCT	Voltaje	IP	Material
22-3002-*	28W	1830	COB CREE	24°	>80	4000K	100-240V	20	Aluminio
11-1735-*	35W	3450	COB CITIZEN	Ajustable 10° a 60°	>80	3000K / 5000K	100-240V	20	Aluminio
11-2925-*	25W	2000	COB CITIZEN	24°	>95	3000K	100-240V	20	Aluminio

ALPHA | LINE



22-6136-*

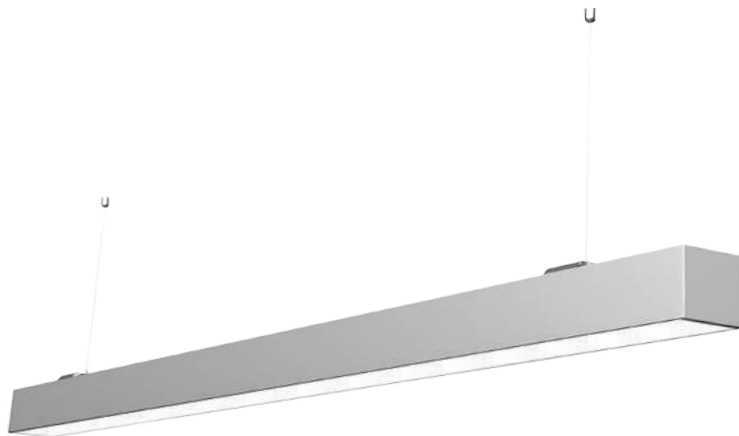
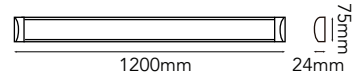

22-2011-*

-03 Gris

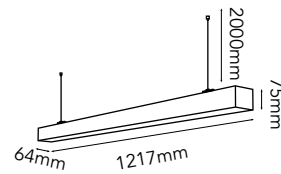

ACCESORIOS

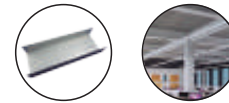

CON-2011

*Se puede suspender o sobreponer



22-2060-*

-03 Gris

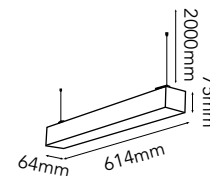

ACCESORIOS



CON-2011

*Se puede suspender o sobreponer

NOTA: Sistema de fijación a techo incluido.

Modelo	LED Watt	Flujo Luminoso	Tipo LED	Ángulo Apertura	CRI	CCT	Voltaje	IP	Material
22-6136-*	36W	2880	SMD	120°	>80	5000K	100-240V	20	Aluminio + PC
22-2011-*	40W	3600	SMD	110°	>80	3000K / 5000K	100-240V	20	Aluminio + PC
22-2060-*	20W	1800	SMD	110°	>80	5000K	100-240V	20	Aluminio + PC

LED PANEL

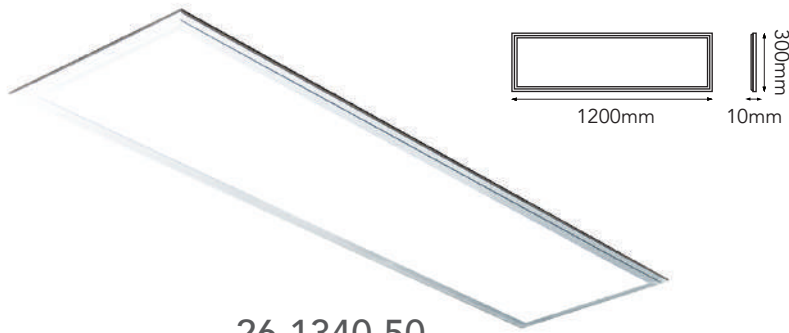

26-1340-50
*Para empotrar.



ACCESORIOS
FR-2613
Kit de marco de aluminio para empotrar.
*Se vende por separado.

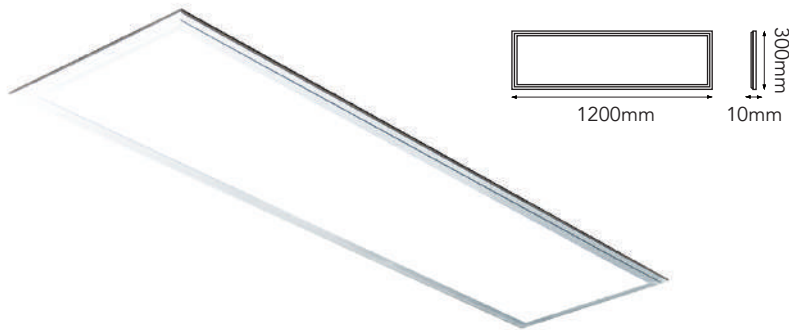

28-1340-50
*Para suspender.
Aluminio 6063 (No se dobla)



ACCESORIOS
CBL-6640
Cable de acero para suspender incluido.

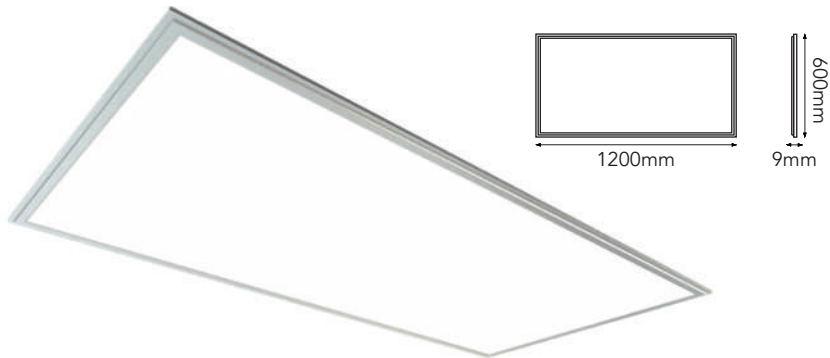

28-6675-50
*Para suspender.
Aluminio 6063 (No se dobla)

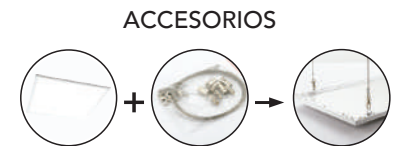

ACCESORIOS
CBL-6640
Cable de acero para suspender incluido.

NOTA: Driver incluido.

Modelo	LED Watt	Flujo Luminoso	Tipo LED	Ángulo Apertura	CRI	CCT	Voltaje	IP	Material
26-1340-50	40W	3800	SMD	120°	>80	5000K	90-240V CA	20	Aluminio + PMMA
28-1340-50	40W	3800	SMD	120°	>80	5000K	90-240V CA	20	Aluminio 6063 + PMMA
28-6675-50	72W	6480	SMD	120°	>80	5000K	90-240V CA	20	Aluminio 6063 + PMMA

LED PANEL | GRID PANEL

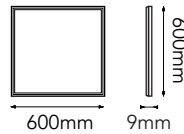

26-6640-50 | 26-6640-50D 

*Para empotrar

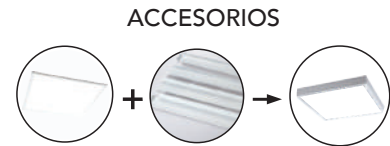

FR-2626

Kit de marco de aluminio para empotrar.
*Se vende por separado.

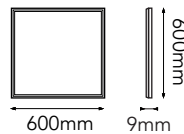

28-6640-50

*Para suspender.
Aluminio 6063 (No se dobla)



CBL-6640

Cable de acero para suspender incluido.

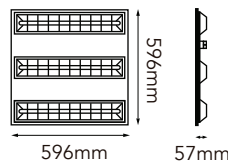

26-2601-* | 26-2601-40D 

-40 (4000K)
-50 (5000K)



CBL-3983

Kit de Cable de acero para suspender.



FR-2626

Kit de Marco de aluminio para empotrar.

Modelo	LED Watt	Flujo Luminoso	Tipo LED	Ángulo Apertura	CRI	CCT	Voltaje	IP	Material
26-6640-50	40W	3600	SMD	120°	>80	5000K	90-240V CA	20	Aluminio + PMMA
28-6640-50	40W	3600	SMD	120°	>80	5000K	90-240V CA	20	Aluminio 6063 + PMMA
26-2601-*	30W	2300	SMD	30°	>80	4000K/5000K	100-277V	20	Aluminio + Acero

CORTESÍA



KRAKEN

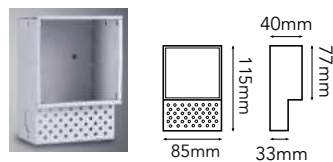
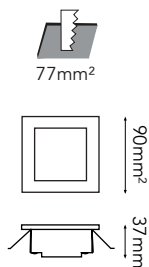

*Housing de hierro incluido

08-0360-*

"Para Uso interior"

-01 Blanco

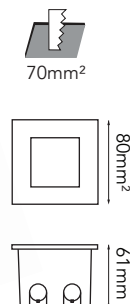

08-7401-*

-08 Acero

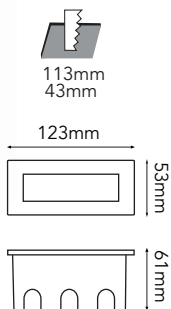

08-7501-*

-08 Acero

NOTA: Driver y Caja de Registro incluidos.

Modelo	LED Watt	Flujo Luminoso	Tipo LED	CCT	Voltaje	IP	Material
08-0360-*	3W	190	CREE SMD	3000K	127V	20	Aluminio + Cristal Templado
08-7401-*	1.5W	75	SMD	3000K	90-130V	65	Aluminio + SS316
08-7501-*	1.5W	75	SMD	3000K	90-130V	65	Acero Inoxidable 316

CONUS

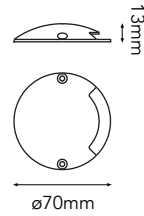

05-2801-* | 05-2807-*
(Kit 3 piezas)

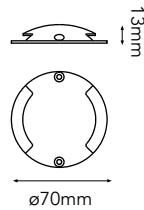

05-2800-* | 05-2806-*
(Kit 3 piezas)

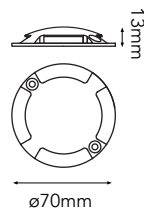

05-2799-* | 05-2805-*
(Kit 3 piezas)

NOTA: Solo en KIT incluyen Transformador.

Modelo	LED Watt	Flujo Luminoso	Tipo LED	CCT	Voltaje	IP	Material
05-2801-* 05-2807-*	0.5W	20	5mm LED	3000K/4000K	12V CA/CD	67	Aluminio
05-2800-* 05-2806-*	0.8W	40	5mm LED	3000K/4000K	12V CA/CD	67	Aluminio
05-2799-* 05-2805-*	1W	60	5mm LED	3000K/4000K	12V CA/CD	67	Aluminio

SHARK

CORTESÍA



08-9002-*

- 03 Gris
- 04 Grafito

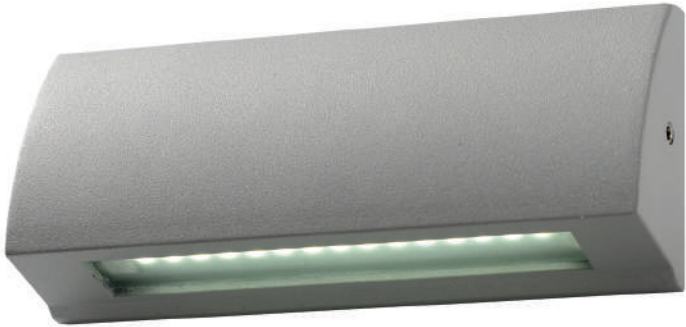
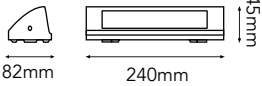

05-9001-*

- 01 Blanco
- 03 Gris
- 04 Grafito

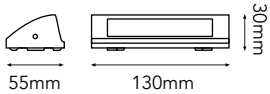

Modelo	LED Watt	Flujo Luminoso	Tipo LED	CCT	Voltaje	IP	Material
08-9002-*	8W	530	SMD	3000K	90-130V	54	Aluminio + Cristal
05-9001-*	3.5W	170	SMD	3000K	90-240V	54	Aluminio + Cristal

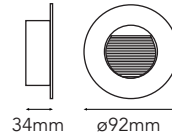
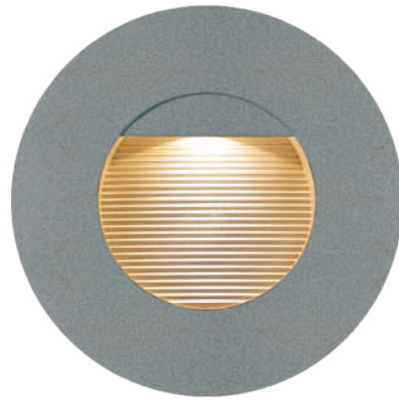

08-9243-*

- 01 Blanco
- 03 Gris
- 04 Grafito

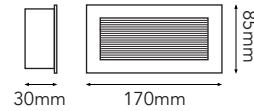
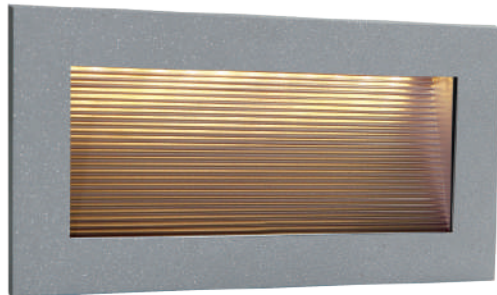

08-9244-*

- 01 Blanco
- 03 Gris
- 04 Grafito

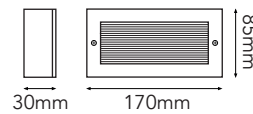
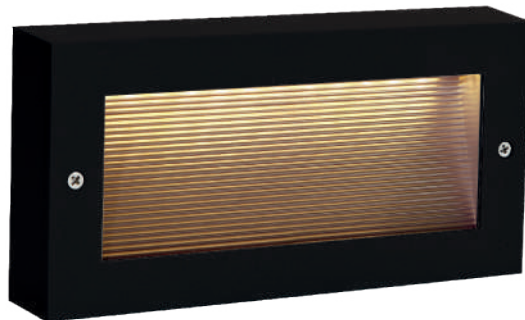

08-9245-*

- 01 Blanco
- 03 Gris
- 04 Grafito
- 07 Negro

NOTA: Housing incluido.

Modelo	LED Watt	Flujo Luminoso	Tipo LED	Ángulo Apertura	CCT	Voltaje	IP	Material
08-9243-*	1W	90	SMD	120°	3000K	100-240V	44	Aluminio
08-9244-*	2.6W	200	SMD	-	3000K	100-240V	44	Aluminio
08-9245-*	2.6W	200	SMD	-	3000K	100-240V	44	Aluminio

KELPIE

CORTESÍA

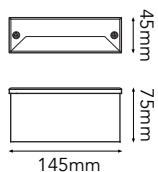
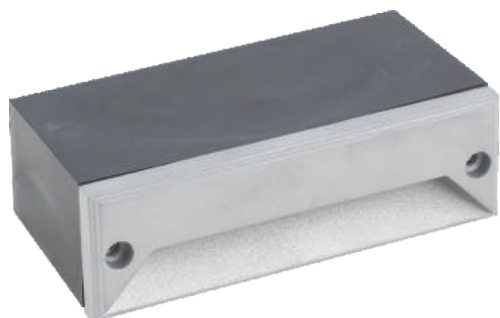

07-4201-*

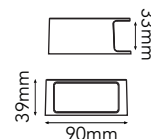
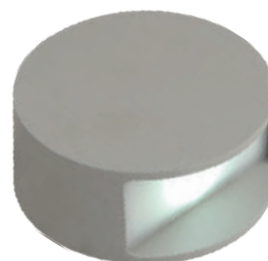

05-7001-*

-03 Gris

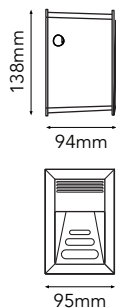

07-2702-*

-03 Gris

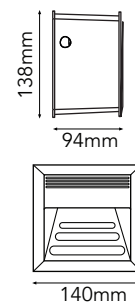

07-1280-*

-03 Gris

Modelo	LED Watt	Flujo Luminoso	Tipo LED	Ángulo Apertura	CCT	Voltaje	IP	Material
07-4201-*	1W	60	SMD	120°	3000K	110-240V	54	Aluminio + PC
05-7001-*	4W	320	SMD	90°	3000K	127V	44	Aluminio
07-2702-*	2.6W	75	SMD	-	3000K	127V	65	Aluminio
07-1280-*	2.6W	90	SMD	-	3000K	127V	65	Aluminio

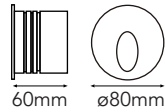

08-1273-*

-02 Satinado

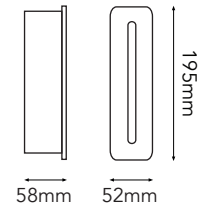
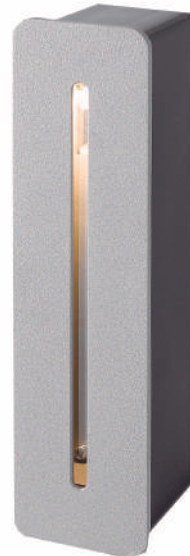

07-1276-*

-01 Blanco -03 Gris

Modelo	LED Watt	Flujo Luminoso	Tipo LED	CCT	Voltaje	IP	Material
08-1273-*	3W	160	SMD CREE	3000K	100-240V	54	Aluminio
07-1276-*	3W	160	SMD CREE	3000K	90-240V	54	Aluminio

OUTDOOR PARED



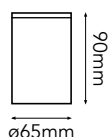

22-9051-*

- 01 Blanco
- 03 Gris
- 04 Grafito

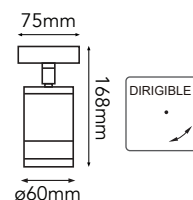

05-8054-*

- 01 Blanco
- 03 Gris
- 04 Grafito

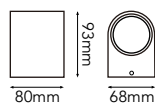

05-7491-*

- 01 Blanco
- 03 Gris
- 04 Grafito

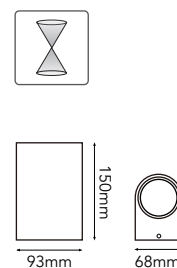

05-7492-*

- 01 Blanco
- 03 Gris
- 04 Grafito

NOTA: Focos no incluidos, Soquet incluido.

Modelo	Watts	Base	Voltaje	IP	Material
22-9051-*	Máx. 35W	GU10	130V	44	Aluminio + Cristal Templado
05-8054-*	Máx. 35W	GU10	130V	44	Aluminio + Cristal Templado
05-7491-*	Máx. 35W	GU10	130V	44	Aluminio + Cristal Templado
05-7492-*	Máx. 2x35W	GU10	130V	44	Aluminio + Cristal Templado

ARIES | OMEGA

OUTDOOR PARED

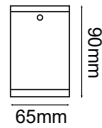

22-7161-*

"A Techo"

-01 Blanco -03 Gris -04 Grafito

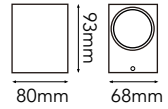

05-7493-*

-01 Blanco -03 Gris -04 Grafito

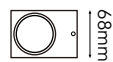
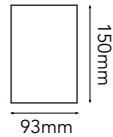

05-7494-*

-01 Blanco -03 Gris -04 Grafito

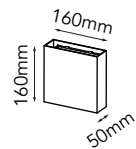

05-1018-*

-03 Gris -04 Grafito

NOTA: Aries: Focos no incluidos, Soquet incluido. Omega: Leds integrados

Modelo	Watts	Flujo Luminoso	Base	Tipo LED	CCT	Voltaje	IP	Material
22-7161-*	Máx. 35W	-	GU10	-	-	130V	44	Aluminio + Cristal Temp
05-7493-*	Máx. 35W	-	GU10	-	-	130V	44	Aluminio + Cristal Temp
05-7494-*	Máx. 2x35W	-	GU10	-	-	130V	44	Aluminio + Cristal Temp
05-1018-*	2x8W	2x560	-	SMD 2835	3000K	127V	65	Aluminio + Cristal

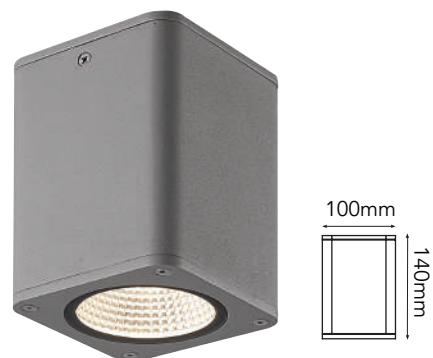

22-2073-*

"A Techo"

-03 Gris



05-2071-*

-03 Gris



05-2072-*

-03 Gris

Modelo	LED Watt	Flujo Luminoso	Tipo LED	Ángulo Apertura	CCT	Voltaje	IP	Material
22-2073-*	12W	870	CREE COB	46°	3000K	100-240V	54	Aluminio
05-2071-*	12W	870	CREE COB	46°	3000K	100-240V	54	Aluminio
05-2072-*	2x12W	870	CREE COB	46°	3000K	100-240V	54	Aluminio

EOS

OUTDOOR PARED

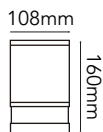

22-7133-*

"A Techo"

-01 Blanco -03 Gris -04 Grafito

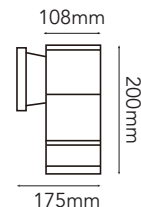

05-7131-*

-01 Blanco -03 Gris -04 Grafito

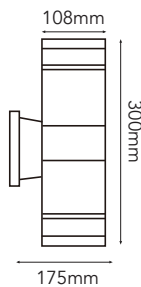

05-7132-*

-01 Blanco -03 Gris -04 Grafito

NOTA: Focos no incluidos, Soquet incluido.

Modelo	Watts	Base	Voltaje	IP	Material
22-7133-*	Máx. 60W	E26	130V	44	Aluminio + Cristal Templado
05-7131-*	Máx. 60W	E26	130V	44	Aluminio + Cristal Templado
05-7132-*	Máx. 2x60W	E26	130V	44	Aluminio + Cristal Templado

FOLDER | MOON | OSIRIS

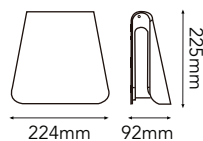
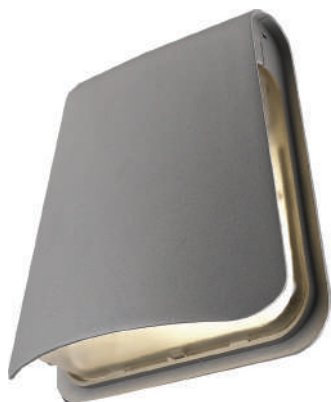

27-1621-*

-03 Gris

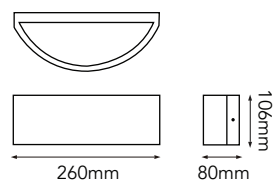

05-5581-*

-03 Gris -04 Grafito

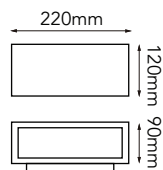

05-7302-*

-01 Blanco -04 Grafito

NOTA: Focos no incluidos, Soquet incluido.

Modelo	Watts	Base	Voltaje	IP	Material
27-1621-*	Máx. 50W	E26	130V	44	Aluminio + PC
05-5581-*	Máx. 18W	E26	130V	44	Aluminio
05-7302-*	Máx. 18W	E26	130V	44	Aluminio

RAMP | ZODIAC | ANDRÓMEDA

OUTDOOR PARED

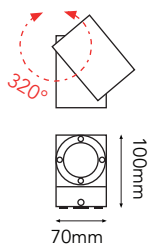

05-1016-*

-03 Gris -04 Grafito

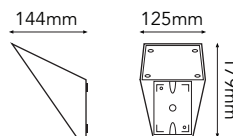

05-1000-*

-03 Gris

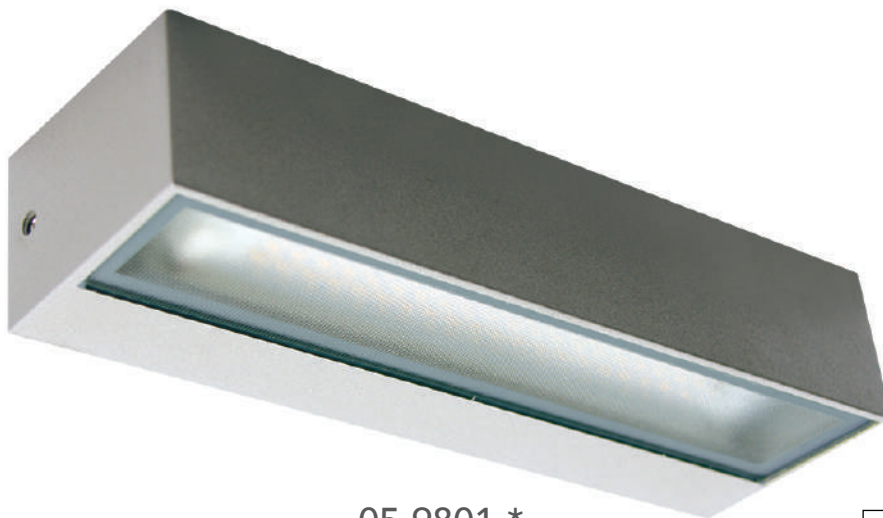

05-9801-*

-03 Gris -04 Grafito

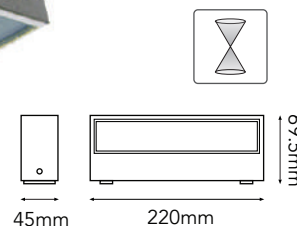

Modelo	LED Watt	Flujo Luminoso	Tipo LED	Ángulo Apertura	CCT	Voltaje	IP	Material
05-1000-*	6W	540	SMD CREE	33°	3000K	100-240V	54	Aluminio
05-1016-*	7W	630	SMD CREE	90°	3000K	100-240V	54	Aluminio
05-9801-*	2x8W	2x490	SMD CREE	-	3000K	90-240V	54	Aluminio



05-1841-*

-01 Blanco -04 Grafito

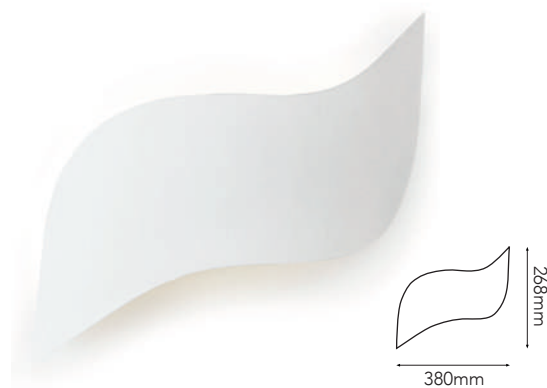

05-0720-*

"Para Uso interior"

-01 Blanco

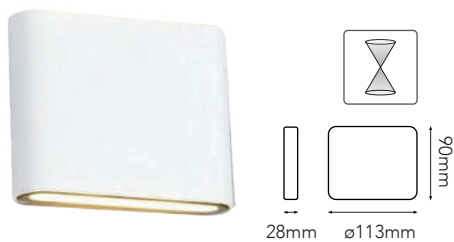

05-8107-*

-01 Blanco -04 Grafito



05-8108-*

-01 Blanco -04 Grafito

Modelo	LED Watt	Flujo Luminoso	Tipo LED	Ángulo Apertura	CCT	Voltaje	IP	Material
05-1841-*	9W	810	SMD	155°	3000K	90-240V	54	Aluminio
05-0720-*	16W	1280	SMD EPISTAR	-	3000K	90-240V	20	Acero
05-8107-*	2x4W	560-640	SMD EPISTAR	-	3000K	90-240V	65	Aluminio +PC
05-8108-*	2x6W	840-960	SMD EPISTAR	-	3000K	90-240V	65	Aluminio +PC

KELPIE II

OUTDOOR PARED

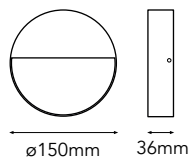

08-1901-*

-04 Grafito

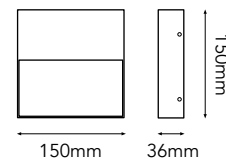

08-2201-*

-04 Grafito

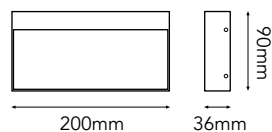
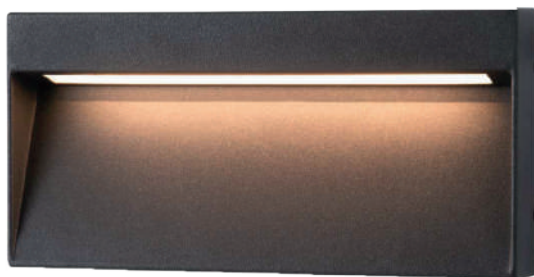

08-2203-*

-04 Grafito

NOTA: Driver Incluido.

Modelo	LED Watt	Flujo Luminoso	Tipo LED	CRI	CCT	Voltaje	IP	Material
08-1901-*	6W	140	SMD	>80	3000K	100-240V	54	Aluminio
08-2201-*	6W	140	SMD	>80	3000K	100-240V	54	Aluminio
08-2203-*	6W	140	SMD	>80	3000K	100-240V	54	Aluminio

DROP | ORIÓN | DIAMANTE



05-1751-*

-03 Gris

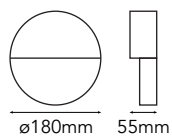

05-2701-*

-01 Blanco -04 Grafito

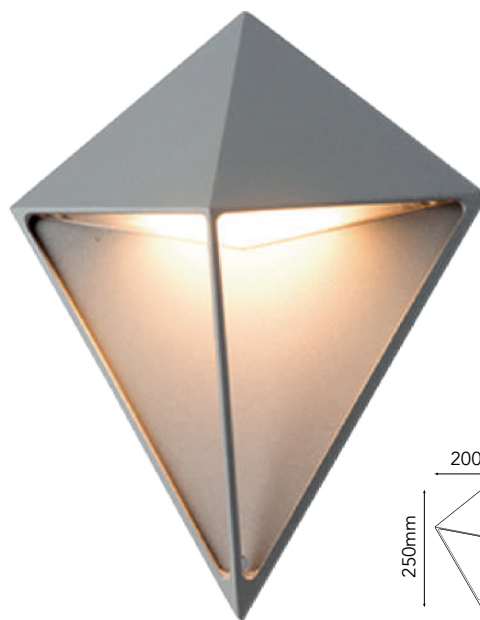
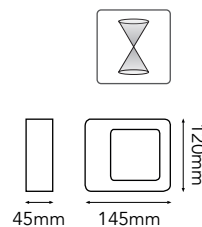

05-2509-*

-03 Gris

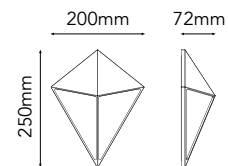

Modelo	LED Watt	Flujo Luminoso	Tipo LED	Ángulo Apertura	CCT	Voltaje	IP	Material
05-2701-*	7W	360	SMD CREE	92°	3000K	100-240V	54	Aluminio + PC
05-1751-*	6W	322	SMD	149°	3000K	100-240V	54	Aluminio + PC
05-2509-*	9W	400	SMD	-	3000K	90-130V	65	Aluminio

OUTDOOR PISO



ONDINA MINI | DIANA | ONDINA



05-9105-*

-07 Negro



05-9205-*

-07 Negro



05-3505-*

-07 Negro



03-4901-*

-04 Grafito

NOTA: Driver y Estaca incluidos.

Modelo	LED Watt	Flujo Luminoso	Tipo LED	Ángulo Apertura	CRI	CCT	Voltaje	IP	Material
05-9105-*	5W	450	COB EPISTAR	30°	>80	3000K/4000K/6000K	90-130V	65	Aluminio
05-9205-*	5W	450	COB EPISTAR	30°	>80	3000K	90-130V	65	Aluminio
05-3505-*	5W	400	SMD	38°	>80	3000K/6500K	100-240V	65	Plástico
03-4901-*	6W	420	SMD	45°	>80	3000K/4000K	100-130VAC	65	Alum + Acrílico

ONDINA

OUTDOOR PISO

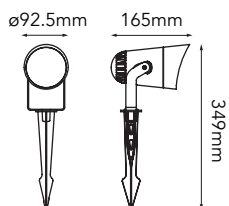

05-2202-*

-04 Grafito



*Housing H0912
(Se vende por separado)

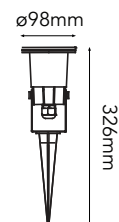

05-0912-*

*Foco no incluido

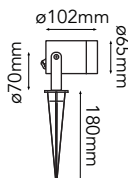

03-4801-*

*Foco no incluido

-04 Grafito

NOTA: Estaca incluida

Modelo	Watts	Flujo Luminoso	Tipo LED	Base	Ángulo Apertura	CCT	Voltaje	IP	Material
05-2202-*	12W	810	SMD CREE	-	23°	3000K	100-240V	65	Aluminio
05-0912-*	Máx. 50W	-	-	GU10	-	-	127V	65	PC
03-4801-*	Máx. 50W	-	-	GU10	-	-	127V	65	Alum+Cristal

OCTOPUS | SMOOTH

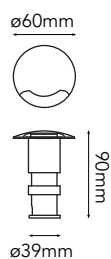

07-0061-*

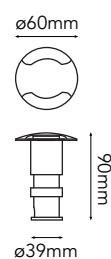

07-0062-*

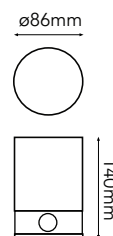
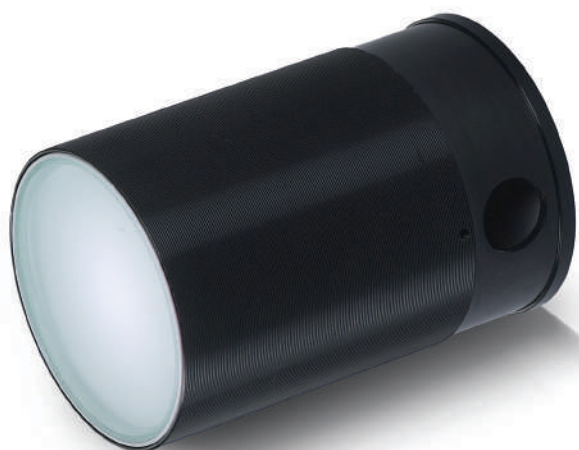

07-2721-*

*Housing Acero,

NOTA: Soportan Paso Vehicular de 2 Toneladas

Modelo	LED Watt	Flujo Luminoso	Tipo LED	Ángulo Apertura	CCT	Voltaje	IP	Material
07-0061-*	2.4W	65	SMD CREE	-	3000K / 4000K	100-240V	65	Aluminio + SS316
07-0062-*	2.4W	192	SMD CREE	-	3000K / 4000K	100-240V	65	Aluminio + SS316
07-2721-*	3W	180	SMD CREE	120°	3000K / 4000K	100-240V	67	Aluminio + Cristal Templado

NINFA

OUTDOOR PISO

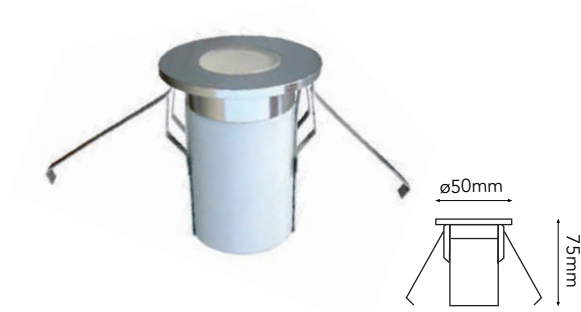

07-1701-*

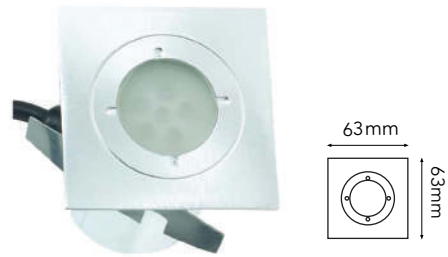

07-1703-*



Modelo	LED Watt	Flujo Luminoso	Tipo LED	Ángulo Apertura	CCT	Voltaje	IP	Material
07-1701-*	.5W	30	5mm LED	45°	3000K/4000K/6000K	127V	67	Aluminio
07-1703-*	.5W	30	5mm LED	58°	3000K / 4000K	127V	67	Aluminio

TERRA | MINI TERRA

OUTDOOR PISO

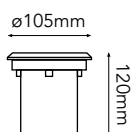

07-0301-*

-08 Acero

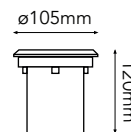

07-0401-*

-08 Acero

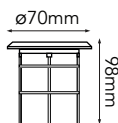

07-1091-*

-08 Acero

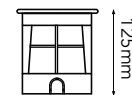
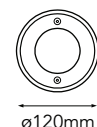

07-9201-*

*Foco no incluido.

-08 Acero

Modelo	LED Watt	Flujo Luminoso	Tipo LED	Base	Ángulo Apertura	CCT	Voltaje	IP	Material
07-0301-*	3W	300	SMD CREE	-	30°	3000K / 4000K	100-240V	67	Aluminio + SS316
07-0401-*	3W	300	SMD CREE	-	30°	3000K / 4000K	100-240V	67	Aluminio + SS316
07-1091-*	1W	80	SMD CREE	-	28°	3000K / 4000K	100-240V	67	Aluminio + SS316
07-9201-*	-	-	-	GU10	-	-	100-240V	67	Aluminio + SS316

TERRA II

OUTDOOR PISO

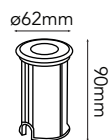

07-62100-*

-08 Acero

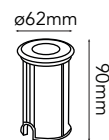

07-62024-*

-08 Acero



Sumergible

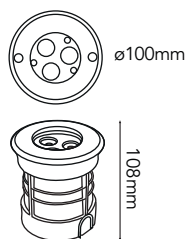

07-30100-*

Modelo	LED Watt	Flujo Luminoso	Tipo LED	Cantidad LED	Ángulo Apertura	CCT	Voltaje	IP	Material
07-62100-*	1W	62	SMD <u>bridgelux</u>	1	45°	3000K	100-240V	67	Aluminio + SS316
07-62024-*	1W	62	SMD <u>bridgelux</u>	1	45°	3000K	24V	68	Aluminio + SS316 
07-30100-*	3W	177	SMD <u>bridgelux</u>	3	45°	3000K	100-240V	67	Aluminio + SS316

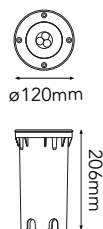

7-06210-*

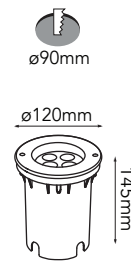

07-6201-*

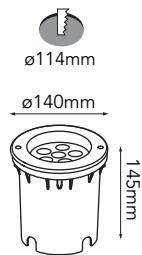

07-6301-*

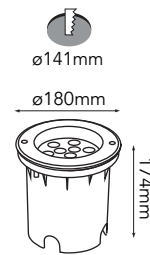

07-6401-*

Modelo	LED Watt	Flujo Luminoso	Tipo LED	Ángulo Apertura	CRI	CCT	Voltaje	IP	IK	Material
7-06210-*	6W	400	SMD CREE	10°	>80	3000K	100-240V	67	10	Aluminio + SS316
07-6201-*	9W	570	SMD 3737	20° / 45°	>80	3000K / 4000K	100-240V	67	10	Aluminio + SS316
07-6301-*	12W	1140	SMD 3737	20° / 45°	>80	3000K / 4000K	100-240V	67	10	Aluminio + SS316
07-6401-*	18W	1710	SMD 3737	20° / 45°	>80	3000K / 4000K	100-240V	67	10	Aluminio + SS316

ATLANTIC II

OUTDOOR PISO

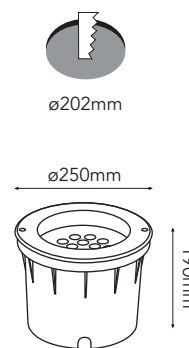

07-7301-*

Modelo	LED Watt	Flujo Luminoso	Tipo LED	Ángulo Apertura	CRI	CCT	Voltaje	IP	Material
07-7301-*	36W	3420	SMD CREE	30°	>80	3000K/4000K	100-240V	67	Aluminio + SS316

OCTOPUS II



07-40921-*

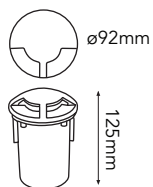
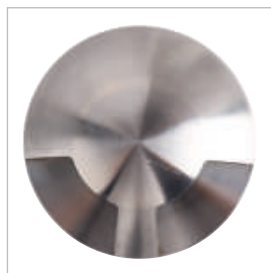

07-40922-*

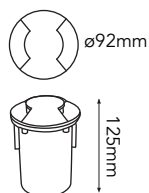

07-40926-*

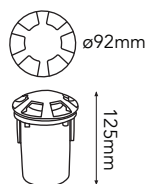

Modelo	LED Watt	Flujo Luminoso	Tipo LED	Cantidad LED	CCT	Voltaje	IP	Material
07-40921-*	3W	270	SMD EPISTAR	22	3000K	100-240V	67	Acero SS316
07-40922-*	3W	300	SMD EPISTAR	22	3000K	100-240V	67	Acero SS316
07-40926-*	3W	330	SMD EPISTAR	22	3000K	100-240V	67	Acero SS316



BUNKER



07-30011-*



07-30012-*

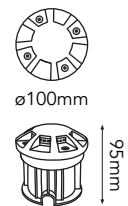

07-30016-*

Modelo	LED Watt	Flujo Luminoso	Tipo LED	Cantidad LED	CCT	Voltaje	IP	Material
07-30011-*	3W	270	SMD	48	3000K	100-240V	67	Aluminio
07-30012-*	3W	300	SMD	48	3000K	100-240V	67	Aluminio
07-30016-*	3W	330	SMD	48	3000K	100-240V	67	Aluminio



07-07300-*

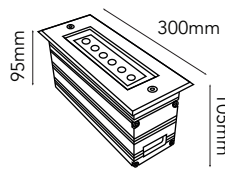

97-06300-*

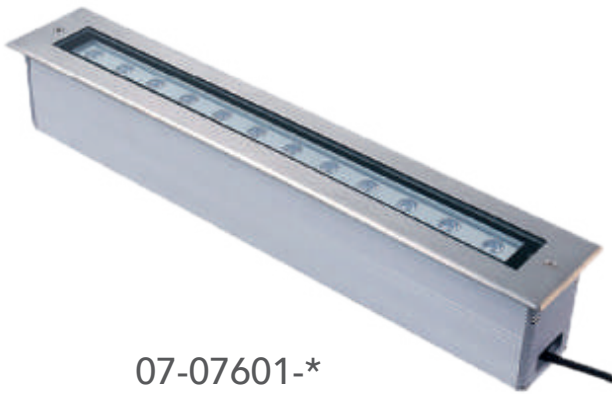
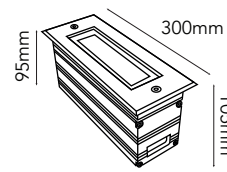

07-07601-*

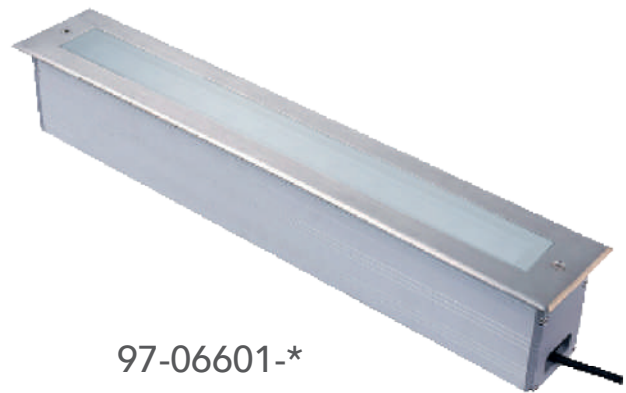
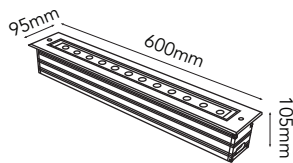

97-06601-*

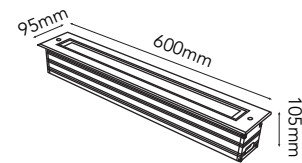

Modelo	LED Watt	Flujo Luminoso	Tipo LED	Cantidad LED	Ángulo Apertura	CCT	Voltaje	IP	Material
07-07300-*	6W	600	SMD <u>bridgelux</u> .	6	45°	3000K	100-240V	67	Aluminio + SS316
97-06300-*	6W	600	SMD <u>bridgelux</u> .	36	120°	3000K	100-240V	67	Aluminio + SS316
07-07601-*	12W	1200	SMD <u>bridgelux</u> .	12	45°	3000K	100-240V	67	Aluminio + SS316
97-06601-*	12W	1200	SMD <u>bridgelux</u> .	72	120°	3000K	100-240V	67	Aluminio + SS316

SUBACUÁTICAS



Inducción Magnética:

- * Acero inoxidable SS316, resistente a la corrosión.
- * Conexión inalámbrica, no hay necesidad de abrir para conectar.
- * Perfecta para aplicaciones debajo del agua, albercas, fuentes y jardines.
- * IP68



De fácil instalación:

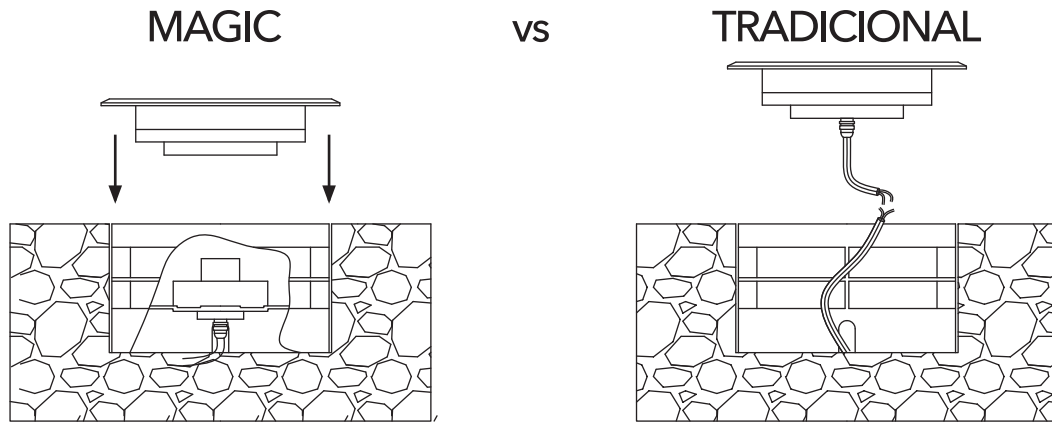

MAGIC

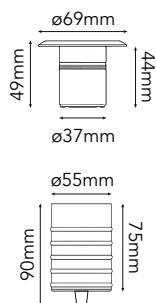

77-1030-*

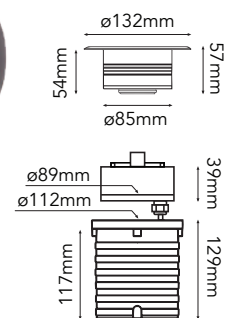

77-1035-*

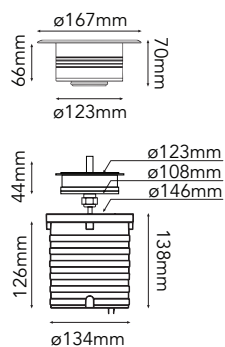

77-1036-*

*Housing de inducción magnética incluido.

Modelo	LED Watt	Flujo Luminoso	Tipo LED	Ángulo Apertura	CRI	CCT	Voltaje	IP	Material
77-1030-*	3W	240	SMD	40°	>80	3000K / 6000K	24V CD	68	Aluminio + Acero SS316
77-1035-*	6W	480	SMD	40°	>80	3000K / 6000K	24V CD	68	Aluminio + Acero SS316
77-1036-*	12W	960	SMD	40°	>80	3000K / 6000K	24V CD	68	Aluminio + Acero SS316

NINFA | HYDROX | MINI HYDRA

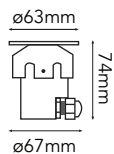

07-1707-*

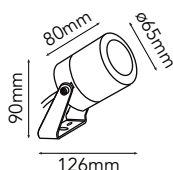

07-4051-*

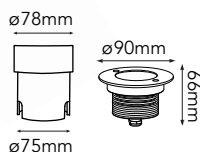

07-4031-*

NOTA: Todos estos productos requieren transformador 12VCD y 24VCD. Además deben trabajar siempre sumergidos en agua.

Modelo	LED Watt	Flujo Luminoso	Tipo LED	Ángulo Apertura	CRI	CCT	Voltaje	IP	Material
07-1707-*	1W	70	SMD CREE	30°	>80	3000K	12V CA/CD	68	Aluminio
07-4051-*	7W	490	SMD	30°	>80	3000K / 4000K	24V CD	68	Acero SS316
07-4031-*	7W	490	SMD	30°	>80	3000K / 4000K	24V CD	68	Acero SS316

HYDRA | AQUA | SQUID



77-4703-*

"Funciona solo debajo del agua"

*Requiere Fuente de Poder



Housing de Acero Inoxidable incluido



05-7021-*

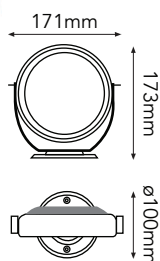

07-0455-*

*Incluye Transformador

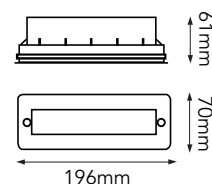

NOTA: Todos estos productos requieren transformador 12VCD / 24VCD. Además deben trabajar siempre sumergidos en el agua.

Modelo	LED Watt	Flujo Luminoso	Tipo LED	Ángulo Apertura	CRI	CCT	Voltaje	IP	Material	
77-4703-*	9W	-	SMD	15°	>80	3000K / 4000K	24V CD	68	SS316	
07-0455-*	3.2W	156	SMD CREE	-	>80	3000K / 4000K	127/12V	68	SS316	
05-7021-NW	30W	1350	SMD	15°	>80	4000K	24V CD	68	SS316	

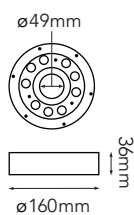

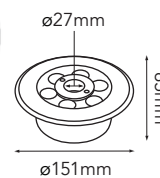

77-0391-*



77-0306-*



Modelo	LED Watt	Flujo Luminoso	Tipo LED	Ángulo Apertura	CRI	CCT	Voltaje	IP	Material
77-0391-*	13.5W	720	SMD CREE	45°	>80	3000K/5000K	24V CD	68	SS316 
77-0306-*	6W	420	SMD bridgelux	45°	-	5000K	24V CD	68	SS304 

BALIZAS



VENUS | ORION

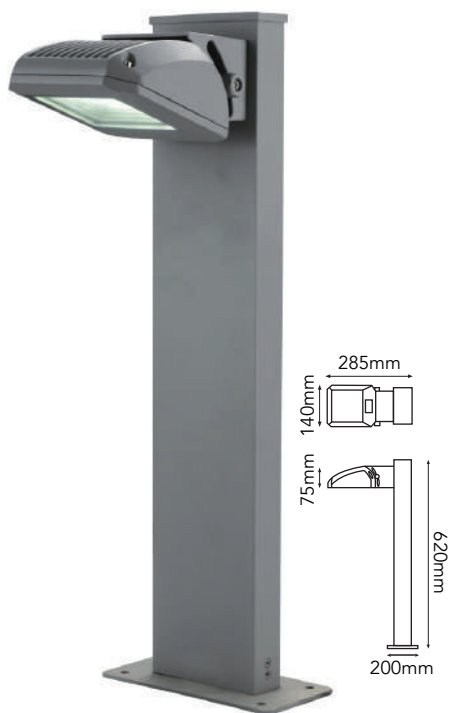

55-2301-*

-03 Gris



55-2704-*

-04 Grafito



10-2704-*

-04 Grafito

Modelo	LED Watt	Flujo Luminoso	Tipo LED	Ángulo Apertura	CRI	CCT	Voltaje	IP	Material
55-2301-*	16W	1460	SMD	100°	>80	4000K	110-240V	65	Aluminio
55-2704-*	5W	360	SMD <i>bridgelux</i>	-	>80	3000K	100-240V	IP55 / Driver IP65	Aluminio
10-2704-*	7W	560	SMD <i>bridgelux</i>	-	>80	3000K	100-240V	IP55 / Driver IP65	Alum + Cable plástico

POLARIS

BALIZAS

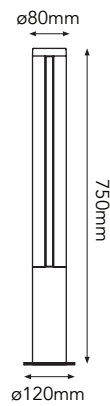

10-2091-*

-04 Grafito

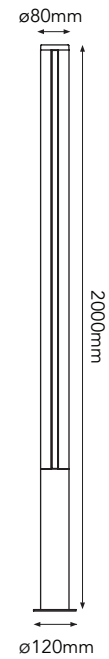

55-2091-*

-04 Grafito

Modelo	LED Watt	Flujo Luminoso	Tipo LED	Ángulo Apertura	CRI	CCT	Voltaje	IP	Material
10-2091-*	9W	500	SMD	112°	>80	3000K	100-240V	IP55 / Driver IP65	Aluminio
55-2091-*	27W	1290	SMD	112°	>80	3000K	100-240V	IP55 / Driver IP65	Aluminio

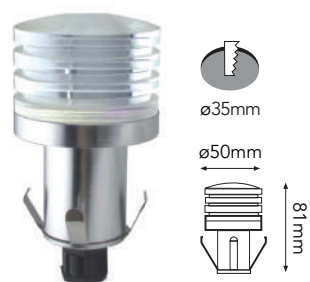

10-1071-*

-03 Gris



10-9107-*

-03 Gris



55-9107-*

-03 Gris

Modelo	LED Watt	Flujo Luminoso	Tipo LED	CRI	CCT	Voltaje	IP	Material
10-1071-*	1W	60	SMD CREE	>80	3000K / 6000K	100-240V	67	Aluminio
10-9107-*	3W	330	SMD CREE	>80	3000K	100-240V	54	Aluminio
55-9107-*	3W	330	SMD CREE	>80	4000K	110-240V	54	Aluminio

CAGE

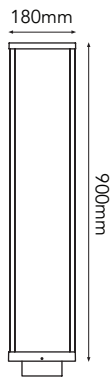

55-1933-*

-05 Bronce Rust

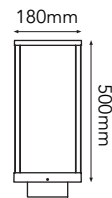

10-1932-*

-05 Bronce Rust

Modelo	LED Watt	Flujo Luminoso	Tipo LED	Ángulo Apertura	CRI	CCT	Voltaje	IP	Material
55-1933-*	12W	700	SMD CREE	125°	>80	3000K	100-240V	IP54	Aluminio
10-1932-*	12W	700	SMD CREE	125°	>80	3000K	100-240V	IP54	Aluminio

REFLECTORES



MEDUSA

REFLECTORES

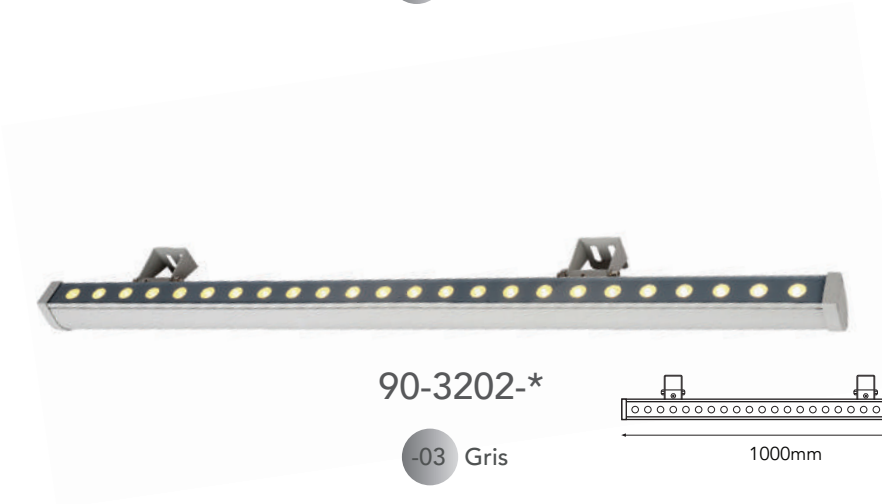
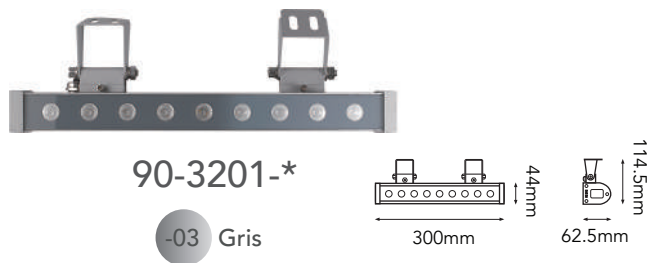
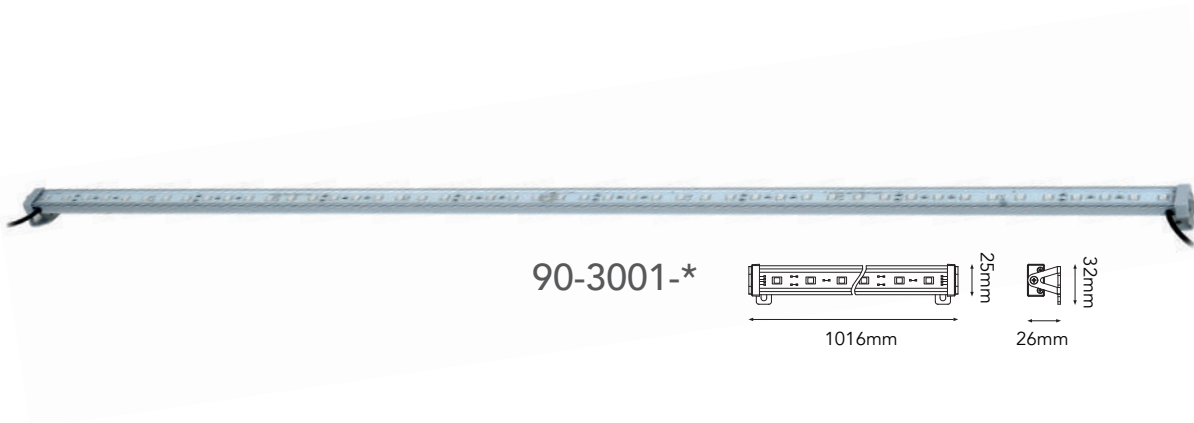

NOTA: Driver incluido, Requieren fuente de poder.

Modelo	LED Watt	Flujo Luminoso	Tipo LED	Ángulo Apertura	CRI	CCT	Voltaje	IP	Material
90-3001-*	11.5W	700	SMD	120°	>80	3000K / 4000K	24V CD	67	Aluminio
90-3201-*	9W	900	SMD	25°x45°	>80	3000K	100-240V	65	Aluminio + Cristal Templado
90-3202-*	24W	2100	SMD CREE	45°	>80	3000K / 4000K	100-240V	65	Aluminio + Cristal Templado

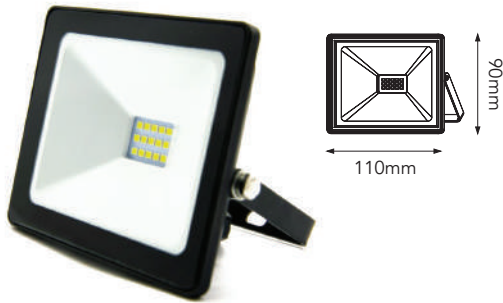

05-0010-*

-07 Negro

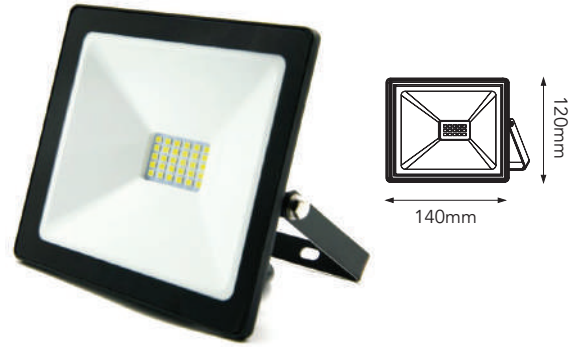

05-0020-*

-07 Negro

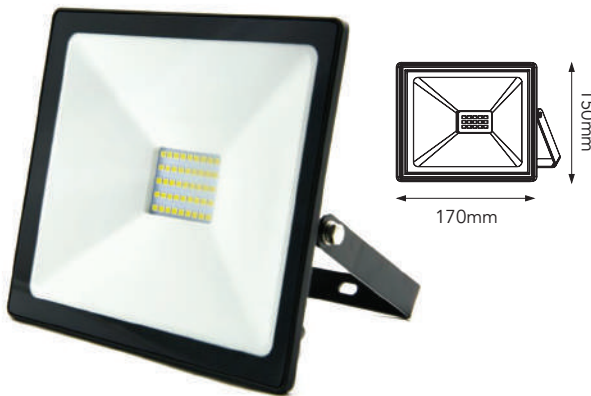

05-0030-*

-07 Negro

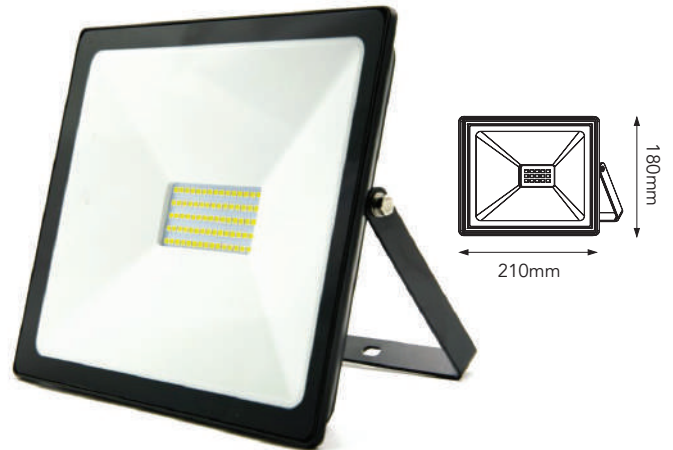

05-0050-*

-07 Negro

NOTA: Driver incluido, 50cm de Cable.

Modelo	LED Watt	Flujo Luminoso	Tipo LED	Ángulo Apertura	CRI	CCT	Voltaje	IP	Material
05-0010-*	10W	900	SMD	120°	>80	3000K / 6000K	90-260V	65	Aluminio
05-0020-*	20W	1700	SMD	120°	>80	3000K / 6000K	85-265V	65	Aluminio
05-0030-*	30W	2700	SMD	120°	>80	3000K / 6000K	90-260V	65	Aluminio
05-0050-*	50W	4500	SMD	120°	>80	3000K / 6000K	90-260V	65	Aluminio

LUMI-THOR

REFLECTORES

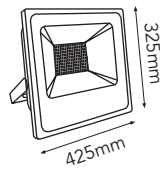

5-25100-*

-07 Negro

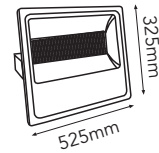

5-25250-*

-07 Negro

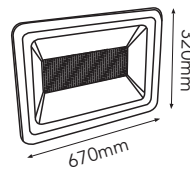

5-25400-*

-07 Negro

Modelo	LED Watt	Flujo Luminoso	Tipo LED	Ángulo Apertura	CRI	CCT	Voltaje	IP	Material
5-25100-*	100W	7000	SMD	120°	>80	3000K / 6000K	85-265V	67	Aluminio + Cristal Templado
5-25250-*	250W	17500	SMD	120°	>80	3000K / 6000K	85-265V	65	Aluminio + Cristal Templado
5-25400-*	400W	30000	SMD	120°	>80	6000K	85-265V	65	Aluminio + Cristal Templado

SISTEMAS RGB



SKY | NINFA | TERRA | ONDINA



6-26752-RGB

*Ajustable 25° vertical y 350° horizontal

-01 Blanco

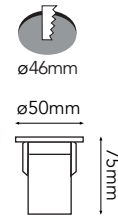

07-1701-RGB

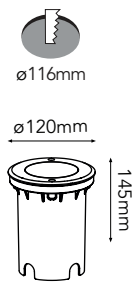

07-0301-RGB

*Incluye Housing

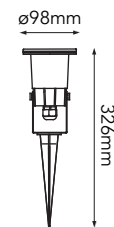

05-0901-RGB

*Estaca se vende por separado

NOTA: Requieren Controlador y Fuente de Poder.

Modelo	LED Watt	Tipo LED	Ángulo Apertura	CCT	Voltaje	IP	Material
6-26752-RGB	9W	COB	38°	RGB	12V CD	20	Aluminio
07-1701-RGB	1.5W	SMD	45°	RGB	12V CD	68	Aluminio + SS316
07-0301-RGB	6W	SMD	45°	RGB	12V CD	67	Tapa SS304
05-0901-RGB	3W	SMD CREE	45°	RGB	12V CD	67	Aluminio

ATLANTIC

SISTEMAS RGB

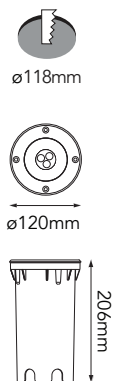

07-6201-RGB

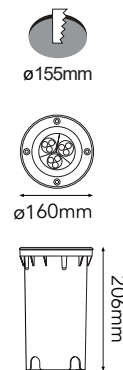

07-6301-RGB

NOTA: Requieren Controlador y Fuente de Poder.

Modelo	LED Watt	Tipo LED	Ángulo Apertura	CCT	Voltaje	IP	Material
07-6201-RGB	6.5W	SMD	33°	RGB	12V	67	Aluminio + SS316
07-6301-RGB	16W	SMD	33°	RGB	12V	67	Aluminio + SS316

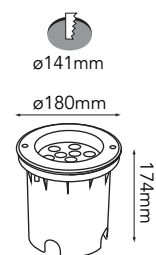

07-6401-RGB

NOTA: Requieren Controlador y Fuente de Poder.

Modelo	LED Watt	Tipo LED	Ángulo Apertura	CCT	Voltaje	IP	IK	Material
07-6401-RGB	18W	SMD 3737	45°	RGB	12V	67	10	Aluminio + SS316

COSMOS



5-21201-RGB

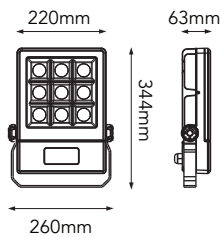

5-21101-RGB

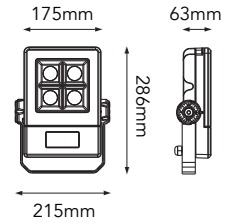

5-21301-RGB

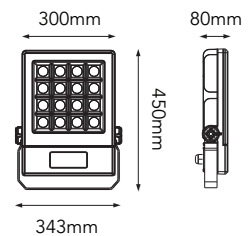

NOTA: Requieren Controlador y Fuente de Poder.

Modelo	LED Watt	Tipo LED	Ángulo Apertura	CCT	Voltaje	IP	Material
5-21101-RGB	22W	SMD CREE	45°	RGB	100-260V	67	Aluminio + Cristal templado
5-21201-RGB	32W	SMD CREE	45°	RGB	100-260V	67	Aluminio + Cristal templado
5-21301-RGB	78W	SMD CREE	45°	RGB	100-260V	67	Aluminio + Cristal templado

MEDUSA



05-0502-RGB

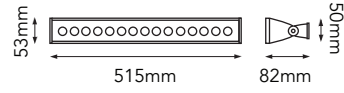

90-2501-RGB

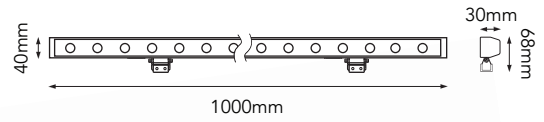

90-3001-RGB

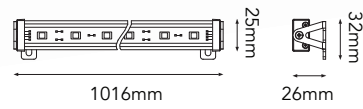

NOTA: Requieren Controlador y Fuente de Poder.

Modelo	LED Watt	Tipo LED	Ángulo Apertura	CRI	CCT	Voltaje	IP	Material
05-0502-RGB	20W	SMD CREE	45°x25°	>80	RGB	24V CD	65	Aluminio
90-2501-RGB	32W	SMD CREE	45°	>80	RGB	24V CD	65	Aluminio
90-3001-RGB	11.5W	SMD CREE	120°	>80	RGB	24V CD	67	Aluminio



DELTA | HYDRA | SQUID

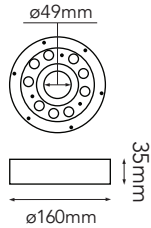

77-0393-RGB

"Funciona solo debajo del agua"

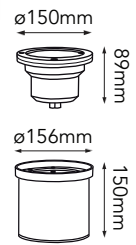

Housing de Acero Inoxidable

77-4703-RGB

"Funciona solo debajo del agua"

*Incluye Housing

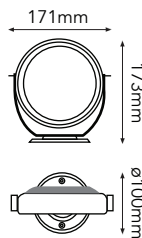

05-7021-RGB



NOTA: Requieren Controlador y Fuente de Poder.

Modelo	LED Watt	Tipo LED	Ángulo Apertura	CRI	CCT	Voltaje	IP	Material	
77-0393-RGB	31.5W	SMD CREE	45°	>80	RGB	24V CD	68	SS316	
77-4703-RGB	17W	SMD CREE	15°	>80	RGB	24V CD	68	SS316	
05-7021-RGB	30W	SMD	15°	>80	RGB	24V CD	68	SS316	

INDUSTRIAL

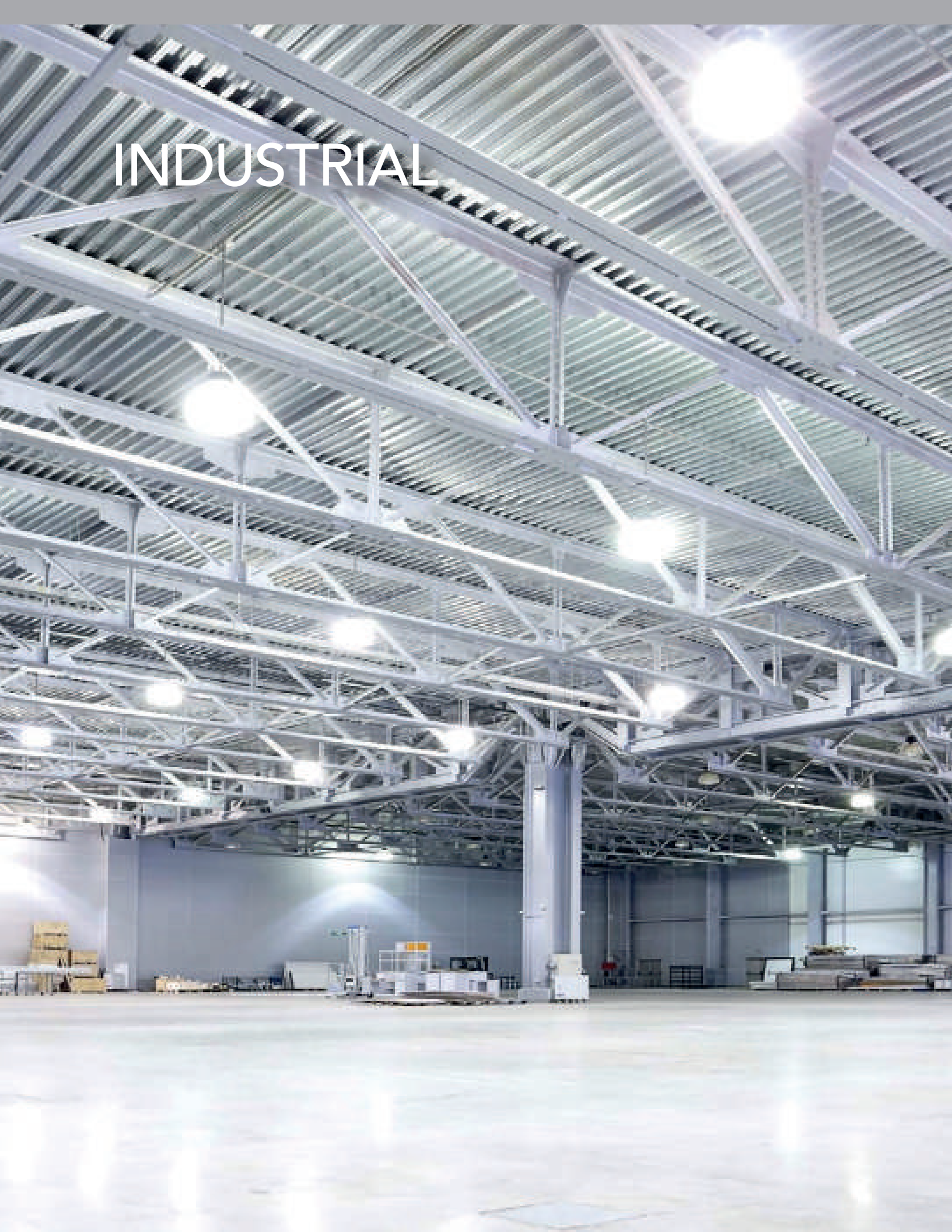

OYSTER | PARIS

INDUSTRIAL



22-0210-*

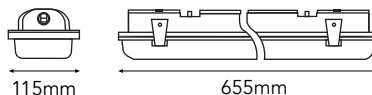

22-0218-*

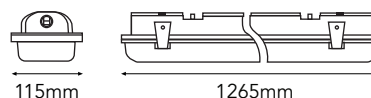

27-4001-40

*Fotocelda se vende por separado

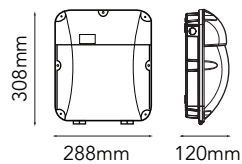

Modelo	LED Watt	Tipo LED	Ángulo Apertura	Flujo Luminoso	CCT	Voltaje	IP	Material
22-0210-*	20W	SMD	180°	2000	6000K	90-260V	65	Aluminio + PC
22-0218-*	36W	SMD	180°	3600	4000K / 6000K	90-260V	65	Aluminio + PC
27-4001-40	50W	COB	120°	4000	4000K	90-260V	65	Aluminio + PC

HIBAY - UFO

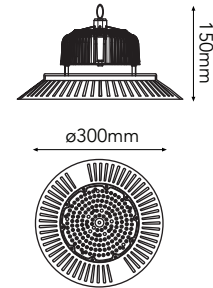

20-3110-50

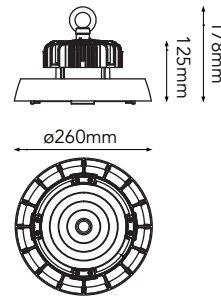

20-7100-50

Lente ajustable patentado para lograr cambios de 60°, 90° y 105°

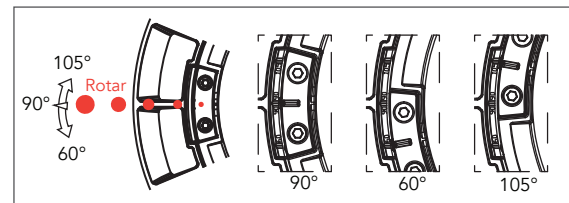

Modelo	LED Watt	Tipo LED	Ángulo Apertura	CRI	Flujo Luminoso	CCT	Voltaje	IP	Material
20-3110-42	100W	SMD	180°	>80	10000	5000K	110-240V	65	Aluminio + PC
20-7100-50	100W	SMD	60°, 90°, 105°	>80	13000	5000K	100-277V	65	Aluminio + PC

URBANA



15-0050-65

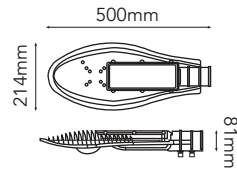

15-0100-65

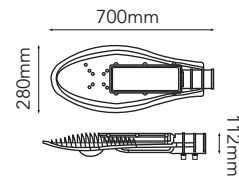

15-0150-65

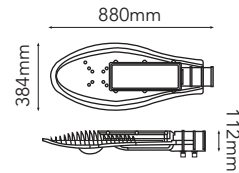

15-0180-65

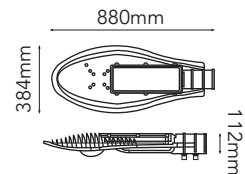

Modelo	LED Watt	Tipo LED	Ángulo Apertura	Flujo Luminoso	CCT	Voltaje	IP	Material
15-0050-65	50W	COB bridgelux	80°x140°	4500	6000K	90-260V	66	Aluminio + Cristal Templado
15-0100-65	100W	COB bridgelux	80°x140°	9000	6000K	90-260V	66	Aluminio + Cristal Templado
15-0150-65	150W	COB bridgelux	80°x140°	13500	6000K	90-260V	66	Aluminio + Cristal Templado
15-0180-65	180W	COB bridgelux	80°x140°	16200	6000K	90-260V	66	Aluminio + Cristal Templado

TIRA LED FLEXIBLE



- Fuente de iluminación: 2835 Top LEDs.
- Manejo térmico extraordinario.
- Salida de luz altamente eficiente.
- Cuerpo de tira compacto, perfecto para cualquier espacio.
- Disponible en diferentes tonos.

MONOCROMÁTICAS BAJO VOLTAJE



FB-72282-*

2835 Top LED (0.2)W

14.4W / metro (72W/5m)
24Volts CD
IP20

*Conectores Disponibles
(Consulte con su distribuidor autorizado)

Emisión Luminosa	Luz Neutra NW (3700-4250K) / 1320 lm/m Luz Cálida WW (2900-3100K) / 1080 lm/m
Dimensiones	5000 x 8 x 1.5mm
Unidad	100mm/6LEDs
Consumo	72W (14.4W/m)
Cantidad de LEDs	300 LEDs (60LEDs/m)
Voltaje	24V CD
Corriente	3A (60mA por unidad)
Humedad Relativa	40%~70%
Temperatura Ambiente	-20°~45°C



FB-43282-*

2835 Top LED (0.2)W

8.64W / metro (43.2W/5m)
24Volts CD
IP20

*Conectores Disponibles
(Consulte con su distribuidor autorizado)

Emisión Luminosa	Luz Neutra NW (3700-4250K) / 792 lm/m Luz Cálida WW (2900-3100K) / 684 lm/m
Dimensiones	5000 x 8 x 1.5mm
Unidad	166.6mm/6LEDs
Consumo	43.2W (8.64W/m)
Cantidad de LEDs	180 LEDs (36LEDs/m)
Voltaje	24V CD
Corriente	1.8A (60mA por unidad)
Humedad Relativa	40%~70%
Temperatura Ambiente	-20°~45°C

MONOCROMÁTICAS BAJO VOLTAJE

TIRA DE LED

FS-43285-*
2835 Top LED (0.2)W
8.64W / metro (43.2W/5m)
24Volts CD
IP54

*Conectores Disponibles
(Consulte con su distribuidor autorizado)



Emisión Luminosa	Luz Neutra NW (3700-4250K) / 792 lm/m Luz Cálida WW (2900-3100K) / 684 lm/m
Dimensiones	5000x8x1.5mm
Unidad	166.6mm/6LEDs
Consumo	43.2W (8.64 W/m)
Cantidad de LEDs	180 LEDs (36LEDs/m)
Voltaje	24V CD
Corriente	1.8A (60mA por unidad)
Humedad Relativa	40%~70%
Temperatura Ambiente	-20°~45°C



Emisión Luminosa	Blanco Neutro NW (3700-4250°K) / 792 lm/m Blanco Cálido WW (2900-3100°K) / 684 lm/m
Dimensiones	5000x8x1.5mm
Unidad	166.6mm/6LEDs
Consumo	43.2W (8.64 W/m)
Cantidad de LEDs	180 LEDs (36LEDs/m)
Voltaje	24V CD
Corriente	1.8A (60mA por unidad)
Humedad Relativa	40%~70%
Temperatura Ambiente	-20°~45°C

FE-43287-*
2835 Top LED

8.64W / metro (43.2W/5m)
24Volts CD
IP67

*Conectores Disponibles
(Consulte con su distribuidor autorizado)

MONOCROMÁTICAS BAJO VOLTAJE



FE-72287-*

2835 Top LED

14.4W / metro (72W/5m)

24Volts CD

IP67

*Conectores Disponibles
(Consulte con su distribuidor autorizado)

Emisión Luminosa	Luz Cálida WW (2900-3100K) / 1080 lm/m Luz Neutra NW (3700-4250K) / 1320 lm/m Luz Fría CW (5700-6500K) / 1320 lm/m
Dimensiones	5000x8x1.5mm
Unidad	100mm/6LEDs
Consumo	72W (14.4 W/m)
Cantidad de LEDs	300 LEDs (60LEDs/m)
Voltaje	24V CD
Corriente	3A (60mA por unidad)
Humedad Relativa	-40%~70%
Temperatura Ambiente	-20°~45°C

CAMBIO DE TEMPERATURA DE COLOR (2300K-6500K)

TIRA DE LED



FS-48356-TC

2016 Top LED

9.6W / metro (48W/5m)

24Volts CD

IP65

*Conectores Disponibles
(Consulte con su distribuidor autorizado)

Emisión Luminosa	Ajustable (2300-6500K)
Dimensiones	5000x14mm
Unidad	100mm/6LEDs
Consumo	48W (9.6W/m)
Cantidad de LEDs	600 LEDs (120LEDs/m)
Voltaje	24V CD
Corriente	2A (40mA por unidad)
Humedad Relativa	40%~70%
Temperatura Ambiente	-20°~45°C

Temperatura de Color Ajustable



2300K Luz Cálida



4000K Luz Neutra



5000K Luz de Día

6500K Luz Fría

RGB / RGBW CAMBIO DE COLOR



FS-0036-RGB 5050 Top LED

8.6W / metro (43.2W/5m)
24Volts CD
IP54

*Conectores Disponibles
(Consulte con su distribuidor autorizado)

Emisión Luminosa	RGB (Cambio de Color)
Dimensiones	5000 x 12 x 4.5mm
Unidad	166.6mm/6LEDs
Consumo	8.6W/m (43.2W/5m)
Cantidad de LEDs	180 LEDs (36LEDs/m)
Voltaje	24V CD
Corriente	2.4A (80mA por unidad)
Humedad Relativa	40%~70%
Temperatura Ambiente	-20°~45°C



FS-96555-RGBW RGBW Top LED

19.2W / metro (96W/5m)
24Volts CD
IP54

*Conectores Disponibles
(Consulte con su distribuidor autorizado)

Emisión Luminosa	RGB+NW (Luz Neutra NW (3900-4300K) / 1008 lm/m)
Dimensiones	5000x12x2.3mm
Unidad	100mm/6LEDs
Consumo	96W (19.2 W/m)
Cantidad de LEDs	300 LEDs (60LEDs/m)
Voltaje	24V CD
Corriente	4A (80mA por unidad)
Humedad Relativa	40%~70%
Temperatura Ambiente	-20°~45°C

¡Todo en uno!

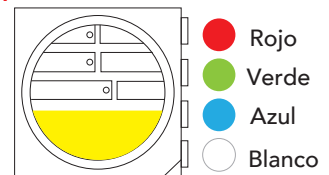



FC-43286-*

2835 Top LED (0.2)W

8.64W / metro (43.2W/5m)

24Volts CD

IP68 

*Conectores Disponibles
(Consulte con su distribuidor autorizado)

Emisión Luminosa	Luz Neutra NW (3700-4250K) / 544 lm/m Luz Cálida WW (2900-3100K) / 544 lm/m
Dimensiones	5000 x 12 x 4.5mm
Unidad	166.6mm/6LEDs
Consumo	43.2W (8.64W/m)
Cantidad de LEDs	180 LEDs (36LEDs/m)
Voltaje	24V CD
Corriente	1.8A (60mA por unidad)
Humedad Relativa	40%~70%
Temperatura Ambiente	-20°~45°C



FS-1036-RGB

5050 Top LED

8.64W / metro (43.2W/5m)

24Volts CD

IP68 

*Conectores Disponibles
(Consulte con su distribuidor autorizado)

Emisión Luminosa	RGB (Cambio de Color)
Dimensiones	5000 x 12 x 4.5mm
Unidad	166.6mm/6LEDs
Consumo	8.64W/m (43.2 W/5m)
Cantidad de LEDs	180 LEDs/5m
Voltaje	24V CD
Corriente	2.4A (80mA por unidad)
Humedad Relativa	40%~70%

TIRA LED 110VCA 2835



Kit de instalación: SET-48110



FV-48110-*

2835 Top LED

9.6W / metro (480W/50m)

110V CA

IP44

Emisión Luminosa | Luz Neutra NW (3700-4250K) / 615 lm/m
Luz Cálida WW (2900-3100K) / 615 lm/m

Dimensiones | Rollo con 50 metros

Consumo | 480W (9.6W/m)

Cantidad de LEDs | 60LEDs/m

Voltaje | 110V AC

Húmedad Relativa | 40%~70%

Temperatura Ambiente | -20°~45°C



FS-27352-*

3528 Top LED

3.6W / metro (180W/50m)

110V CA

IP44

Emisión Luminosa | Luz Cálida WW (2900-3100K) / 230 lm/m
Luz Fría CW (5700-6500K) / 260 lm/m

Dimensiones | Rollo con 50 metros

Consumo | 180W (3.6W/m)

Cantidad de LEDs | 60LEDs/m

Voltaje | AC 110V

Húmedad Relativa | 40%~70%

Temperatura Ambiente | -20°~45°C



Kit de instalación: SET-27352

AP-1616

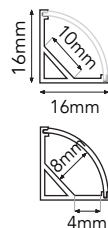
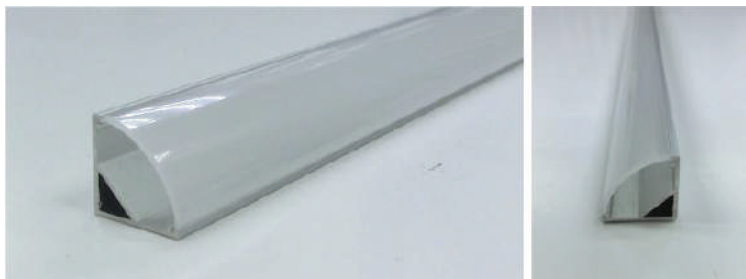

*Longitud: 1m

PERFILES

ACCESORIOS



*Tapa final

MATERIAL:

1. Perfil de Aluminio 6063 con Aleación de Óxido en la superficie
2. Cubierta de PC Opalino
3. Tapa de Plástico
4. Grapa de Acero Inoxidable

AP-2507

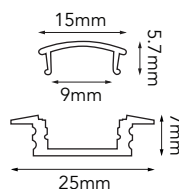

*Longitud: 1m

ACCESORIOS



*Tapa final

MATERIAL:

1. Perfil de Aluminio 6063 con Aleación de Óxido en la superficie
2. Cubierta de PC Opalino
3. Tapa de Plástico
4. Grapa de Acero Inoxidable

AP-2811

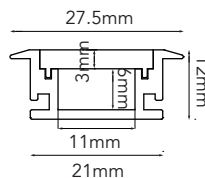
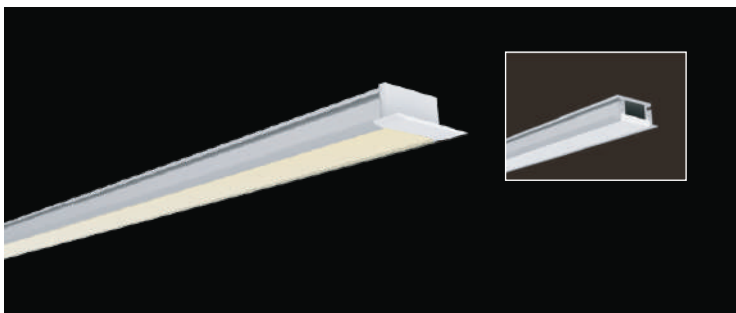

*Longitud: 1m

ACCESORIOS



*Tapa final

MATERIAL:

1. Perfil de Aluminio 6063 con Aleación de Óxido en la superficie
2. Cubierta de PC Opalino
3. Tapa de Plástico

FUENTES DE PODER

PS-12025



- Fuente de Poder
- 25W
- Voltaje de Entrada 90-137 VCA
- Voltaje de Salida 12V CD
- Temperatura de Trabajo:
-20°~60°C / 20%~90%
- Tamaño(mm) 85(L) x 58(W) x 38(H)
- Uso interior

PS-12050

/

PS-24050



- Fuente de Poder
- 50W
- Voltaje de Entrada 90-137 VCA
- Voltaje de Salida 12V CD
- Temperatura de Trabajo:
-20°~60°C / 20%~90%
- Tamaño(mm) 110(L) x 78(W) x 35(H)
- Uso interior

- Fuente de Poder
- 50W
- Voltaje de Entrada 90-137 VCA
- Voltaje de Salida 24V CD
- Temperatura de Trabajo:
-20°~60°C / 20%~90%
- Tamaño(mm) 110(L) x 78(W) x 35(H)
- Uso interior

PS-12100

/

PS-24100



- Fuente de Poder
- 100W
- Voltaje de Entrada 90-137 VCA
- Voltaje de Salida 12V
- Temperatura de Trabajo:
-20°~60°C / 20%~90%
- Tamaño(mm) 159(L) x 97(W) x 38(H)mm
- Uso interior

- Fuente de Poder
- 100W
- Voltaje de Entrada 90-137 VCA
- Voltaje de Salida 24V
- Temperatura de Trabajo:
-20°~60°C / 20%~90%
- Tamaño(mm) 159(L) x 97(W) x 38(H)
- Uso interior

FUENTES DE PODER



PS-12150

/

PS-24150

- Fuente de Poder
- 150W
- Voltaje de Entrada 90V-137VCA
- Voltaje de Salida 12V CD
- Temperatura de Operación:
-20°~60°C / 20%~90%
- Medidas (mm): 199(L) x 98(W) x 42(H)
- Uso interior

- Fuente de Poder
- 150W
- Voltaje de Entrada 90V-137VCA
- Voltaje de Salida 24V CD
- Temperatura de Operación:
-20°~60°C / 20%~90%
- Medidas (mm): 199(L) x 98(W) x 42(H)
- Uso interior



PS-12250

/

PS-24250

- Fuente de Poder
- 250W
- Voltaje de Entrada 90V-137VCA
(Cambia con Switch)
- Voltaje de Salida 12V CD
- Temperatura de Operación:
-20°~60°C / 20%~90%
- Medidas (mm): 200(L) x 110(W) x 50(H)
- Uso interior

- Fuente de Poder
- 250W
- Voltaje de Entrada 90V-137VCA
- Voltaje de Salida 24V CD
- Temperatura de Operación:
-20°~60°C / 20%~90%
- Medidas (mm): 200(L) x 110(W) x 50(H)
- Uso interior



PS-24400

- Fuente de Poder
- 400W
- Voltaje de Entrada 90V-137VCA
- Voltaje de Salida 24V
- Temperatura de Operación:
-20°~60°C / 20%~90%
- Medidas (mm): 215(L) x 115(W) x 50(H)
- Uso interior

TRANSFORMADORES



TRA-1245

- Transformador de voltaje
- 45W
- Voltaje de Entrada 90V-137VCA
- Voltaje de Salida 12V CD
- Frecuencia: 47-63Hz
- Temperatura de Operación: -20°~60°C / 20%~90% HR
- Medidas (mm): 230 (L) x 40 (W) x 20 (H)



TRA-2430

- Transformador de voltaje
- 30W
- Voltaje de Entrada 90V-137VCA
- Voltaje de Salida 24V / 2.5A
- Frecuencia: 47-63Hz
- Temperatura de Operación: -20°~60°C / 20%~90% HR
- Medidas (mm): 200 (L) x 30 (W) x 20 (H)



TRA-2460

- Transformador de voltaje
- 60W
- Voltaje de Entrada 90V-137VCA
- Voltaje de Salida 24V CD
- Frecuencia: 47-63Hz
- Temperatura de Operación: -20°~60°C / 20%~90% HR
- Medidas (mm): 175(L) x 72(W) x 45(H)



TR/50W/S

- Transformador de voltaje
- 127/12V CA para foco
- MR-16, Gx5.3
- IP65



TRA-12100

- Transformador de voltaje
- 100W
- Voltaje de Entrada 90V-130V CA
- Voltaje de Salida 12V CD/ 8.3A
- Frecuencia: 47-63Hz
- IP67
- Temperatura de Operación: -20°~60°C / 20%~90% HR
- Medidas: L185 x W69 x H43mm

TRA-24100

- Transformador de voltaje
- 100W
- Voltaje de Entrada 90V-130V CA
- Voltaje de Salida 24V CD/ 8.2A
- Frecuencia: 47-63Hz
- IP67
- Temperatura de Operación: -20°~60°C / 20%~90% HR
- Medidas : L185 x W69 x H43mm



TRA-12200

- Transformador de voltaje
- 200W
- Voltaje de Entrada 90V-130V CA
- Voltaje de Salida 12V CD/ 8.2A
- Frecuencia: 47-63Hz
- IP67
- Temperatura de Operación: -10°~60°C / 20%~90% HR
- Medidas: L240 x W69 x H43mm

TRA-24200

- Transformador de voltaje
- 200W
- Voltaje de Entrada 90V-130V CA
- Voltaje de Salida 24V CD/ 8.2A
- Frecuencia: 47-63Hz
- IP67
- Temperatura de Operación: -10°~60°C / 20%~90% HR
- Medidas: L240 x W69 x H43mm

DRIVERS



ACT-140350

- Driver CC
- 10W
- 100-240V CA, 350mA
- 10-42V DC
- IP65



ACT-150350F

- Driver CC
- 10W
- 100-240V CA, 350mA
- 12-42V DC
- IP20



ACT-0803 / ACT-0873

- | | |
|---|---|
| <ul style="list-style-type: none"> • Driver 3W, 350mA C.C., • 12V CD Voltaje Constante. • IP65 | <ul style="list-style-type: none"> • Driver 3W, 700mA C.C., • 6V Voltaje Constante. • IP65 |
|---|---|



Líderes en control LED

2019 - 2020

www.astroled.com.mx

DX series

Controlador LED Panel Touch

Controladores de pared touch que hacen la vida más simple.



Caja para instalación CR-D1
*Se vende por separado

DX-1 Atenuación

- » Voltaje de Entrada 100-240V CA
- » Señal de Salida RF 2.4G+DMX512
- » Modo de Control Control Sync
- » Temperatura Trabajo -20°~60°C
- » Dimensiones L86×W86×H36mm
- » Peso (N.W.) 225g



DX-2TC Temperatura de Color

- » Voltaje de Entrada 100-240V CA
- » Señal de Salida RF 2.4G+DMX512
- » Modo de Control Control Sync
- » Temperatura Trabajo -20°~60°C
- » Dimensiones L86×W86×H36mm
- » Peso (N.W.) 225g



DX3-RGB Cambio de Color

- » Voltaje de Entrada 100-240V CA
- » Señal de Salida RF 2.4G+DMX512
- » Modo de Control Control Sync
- » Temperatura Trabajo -20°~60°C
- » Dimensiones L86×W86×H36mm
- » Peso (N.W.) 225g



DX-5 Atenuación, Zonas y Escenas

- » Voltaje de Entrada 100-240V CA
- » Señal de Salida RF 2.4G+DMX512
- » Modo de Control Control Sync
- » Temperatura Trabajo -20°~60°C
- » Dimensiones L86×W86×H36mm
- » Peso (N.W.) 225g



DX-7TC Temp Color, Zonas y Escenas

- » Voltaje de Entrada 100-240V CA
- » Señal de Salida RF 2.4G+DMX512
- » Modo de Control Control Sync
- » Temperatura Trabajo -20°~60°C
- » Dimensiones L86×W86×H36mm
- » Peso (N.W.) 225g



DX8-RGBW Cambio de Color y Blanco

- » Voltaje de Entrada 100-240V CA
- » Señal de Salida RF 2.4G+DMX512
- » Modo de Control Control Sync
- » Temperatura Trabajo -20°~60°C
- » Dimensiones L86×W86×H36mm
- » Peso (N.W.) 225g



NOTA: Controladores de pared "Touch" requieren de los receptores REC-R4 para operar.

Receptor LED



REC-R4-5A



REC-R4-CC

Especificaciones Técnicas



REC-R4-5A

MODELO:
REC-R4-5A

DIMENSIONES:
L175xW44xH30mm

PESO:
150g

PARÁMETROS DE PRODUCTO

- » Compatible con: DX1/DX2/DX3/DX4/DX5/DX6/DX7/DX8
- » Voltaje Entrada: 5~24VDC
- » Máx. Corriente de Carga: 5A x 4CH Máx. 20A
- » Máx. Poder de Salida: 100W/240W/480W(5V/12V/24V)
- » Temp. de Trabajo: -30°~55°C



REC-R4-CC

MODELO:
REC-R4-CC

DIMENSIONES:
L175xW44xH30mm

PESO:
165g

PARÁMETROS DE PRODUCTO

- » Compatible con: DX1/DX2/DX3/DX4/DX5/DX6/DX7/DX8
- » Voltaje Entrada: 12~48VDC
- » Voltaje Salida: 3~46VDC
- » Corriente Salida: CC 350/700/1050mA x 4CH
- » Poder Salida: 1.05W~48.3W x 4CH Máx. 193.2W
- » Temp. de Trabajo: -30°~55°C

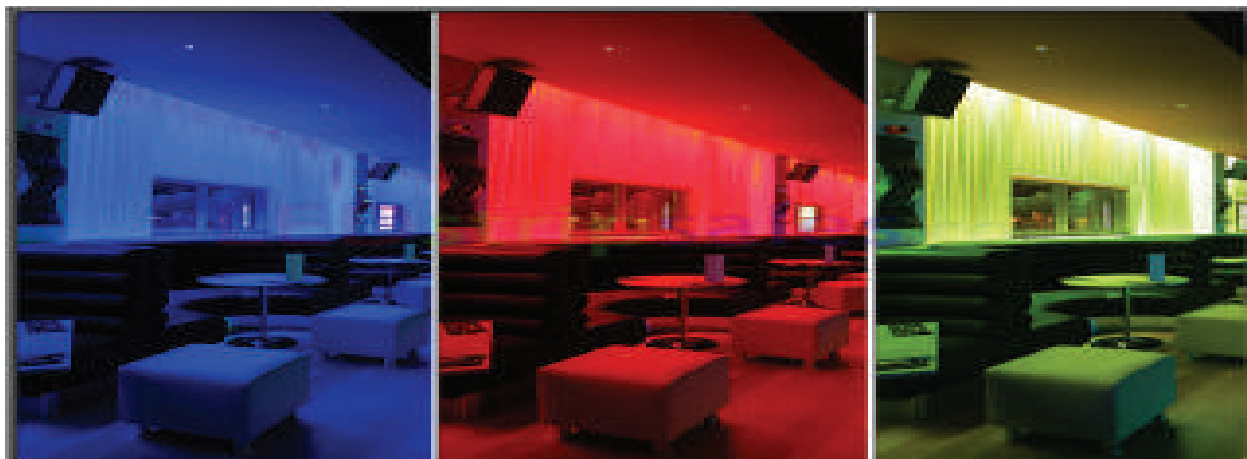

Sistema Inteligente WiFi LED

Puede ser conectado directamente a WiFi-104



- » Puede ser controlado con su dispositivo móvil y control remoto.
- » Apropriado para cualquier tipo de iluminación dentro de su hogar.

K1/K2

Touch Switch Panel Serie de panel inteligente touch



Touch panel sensible al tacto, switch On/Off de rápida respuesta. Encienda o apague la luz de cualquier habitación con tan solo un suave y delicado toque.



De fácil instalación, caja de fijación CR-D1



K1



K2

- Voltaje de Entrada: 220V CA, 50Hz
- Tipo de Carga: Lámpara incandescente, lámparas fluorescentes, lámparas LED.
- Máx. Poder de Carga: 200WxCH
- Mín. Poder de Carga: 5WxCH
- Temperatura: -20°~55°C
- Peso (N.W): 205g

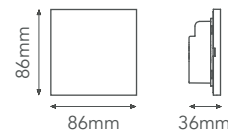

Receptor y Repetidores LED



REP-3063

- » Repetidor de señal para RGB y Dimers de bajo voltaje
- » IP 67
- » Potencias: 45W/108W/216W(5V/12V/24V)



REP-3060

- » Repetidor RGB y Dimers de bajo voltaje CC y CV
- » Potencias: 75W/180W/360W(5V/12V/24V)



REP-3070

- » Repetidor RGB y Dimers de bajo voltaje CC y CV
- » Potencias: 28W/ 576W/ 864W /1152W
(12V / 24V/ 36V/ 48V)

L-BUS WiFi-106

Sistema de Control de Iluminación



WiFi-106

L-BUS es un sistema de control de iluminación que consiste de dos partes; una aplicación y el controlador WiFi. Con nuestra aplicación puede controlar varios tipos de iluminación LED.

Con este sistema usted puede controlar cambio de Tempertura de Color, Atenuación, RGB y RGBW, además de poder crear 12 zonas distintas. Se puede conectar directamente o utilizando un router.

WiFi-106

- » Standard de Comunicación: 2.4GHz WiFi, Protocolo 802.11b/g/n
- » Voltaje de Entrada: 12~24VCD
- » Corriente de Salida: 4Ax4CH Máx.16A
- » Máx. Poder de Salida: (0~48W...96W) x 4CH Max:348W
- » Control de Salida: CT, Atenuación, RGB, RGBW
- » Temp. de Operación: -30°~55°C
- » Dimensiones: L128xW73xH45(mm)
- » Peso: 470g

Control Remoto - F12

- » Voltaje de Operación: 3VCD (Batería CR2032)
- » Frecuencia Wireless: RF 2.4GHz
- » Peso: 85g



L-BUS WiFi-106

Sistema de Control de Iluminación

Accesorios Disponibles

Touch Panel

Control de 1 Zona - Señal de Salida: RF+DMX512



Control de Zonas Múltiples -Señal de Salida: RF+DMX512



Control de Atenuación Señal de Salida: RF+DMX512



Touch Panel Alto Poder Señal de Salida: RF+Poder de Salida



Control Remoto



RF relay



EBOX-AP

Repetidor de Señal



RF a DMX
EBOX-DMX



RF a 0-10V
EBOX-AD



RF a Triac
EBOX-TD

Receptor



F4-3A F4-5A F4-CC F4-DMX-5A F5-DMX-4A



Conexión directa



RF WIRELESS
Menos es más



3 Controles Remotos
distintos, 1 receptor



Controlador Mini
RGB-3-3A

Controlador RGB-3-3A

- | | |
|---------------------------|---------------------|
| » VoltajeEntrada | DC12V-DC24V |
| » Máx. Corriente de Carga | Máx. 3A × 3CH |
| » Máx. Poder de Salida | 108W/216W (12V/24V) |
| » Temp. de Operación | -30°~55°C |
| » Dimensiones | L135×W30×H20mm |
| » Peso (N.W.) | 47g |

Mini Controles. En Kit o Individuales

Nuestro Kit incluye Control Remoto + Controlador.



CM-1 M1+RGB-33A
CR Dimeo



CM-2 M2+RGB-33A
CR Temp Color



CM-6 M6+RGB-33A
Cambio de Color



Mini para RGB M8+M4-5A
Cambio de Color



RGB-3600

- » Controlador RGB, 32 Secuencias, con memoria: 4 escenas
- » Incluye control remoto
- » Voltaje de entrada DC12V~DC24V
- » Máx. poder de salida: 216W/432W(12V/24V)
- » Dimensiones: L211×W40×H30(mm)



RGB-0300

- » Controlador DMX RGB, 39 Secuencias.
- » Incluye control remoto
- » Voltaje Entrada 12V CD~24VCD
- » Máx. Poder de Carga: 288W/576W/(12V/24V)
- » Escala de Grises de Salida:
- » Modo DMX: 256niveles/CH,
- » RGB modo: 1024 nivles/CH
- » Dimensiones: L163×W108×H40mm

Dseries

Controlador LED
Panel Touch
Bajo Voltaje

Controladores de pared touch que hacen la vida más simple.



DIM-D1



D2-TC



E35-RGB

DIM-D1

- » Voltaje de Entrada DC12V~DC24V
- » Máx. corriente de carga 4A x 3CH Máx. 12A
- » Máx. poder salida 144W/288W (12V/24V)
- » Nivel escala grises 4096
- » Temp. de Operación -20° ~ 60°C
- » Dimensiones L86xW86xH36mm
- » Peso (N.W.) 210g



D2-TC

- » Voltaje de Entrada DC12V~DC24V
- » Máx. corriente de carga 4A x 3CH Máx. 8A
- » Máx. poder salida 96W/192W (12V/24V)
- » Temp. de Operación -20° ~ 60°C
- » Dimensiones L86xW86xH36mm
- » Peso (N.W.) 210g



E35-RGB

- » Voltaje de Entrada DC12V~DC24V
- » Máx. corriente de carga 4Ax3CH Máx. 12A
- » Máx. poder salida 96Wx3CH Máx. 288W
- » Temp. de Operación -20° ~ 55°C
- » Dimensiones L86xW86xH36mm
- » Peso (N.W.) 225g



Diagrama de Cableado:

Ejemplo de Cableado 1: Conexión con tira 12V, Máx. 144W(12V)



Ejemplo de Cableado 2: Conexión con tira 24V, Máx. 288W(24V)



*Se vende por separado

PRODUCTOS NUEVOS 2020

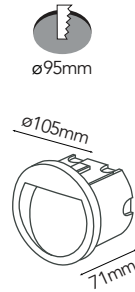

08-8301-*

-03 Gris -04 Grafito

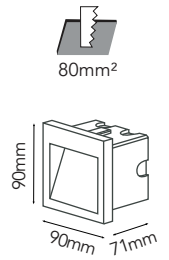

08-8401-*

-03 Gris -04 Grafito

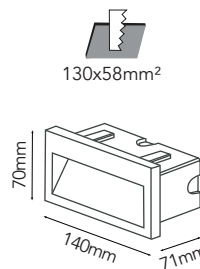

08-8501-*

-03 Gris -04 Grafito

Modelo	LED Watt	Flujo Luminoso	Tipo LED	CCT	Voltaje	IP	Material	
08-8301-*	3W	105	SMD 2835	3000K	90-130V	54	Aluminio + Cristal	
08-8401-*	3W	105	SMD 2835	3000K	90-130V	54	Aluminio + Cristal	
08-8501-*	3W	105	SMD 2835	3000K	90-130V	54	Aluminio + Cristal	

¡Celebremos
10 años contigo!



www.astroled.com.mx

 Facebook: [astroledlighting](https://www.facebook.com/astroledlighting)

