

CALUX[®]
ILUMINA MEJOR



CATÁLOGO | 2019-2020





Ilumina tus mejores momentos

Para nosotros la luz juega uno de los roles más importantes en el diseño de cualquier proyecto arquitectónico, por tal razón desde hace más de 50 años nos enfocamos en brindar la mejor tecnología, calidad, innovación y diseño a través de nuestros productos.

Le invitamos a explorar nuestra amplia línea de luminarias que avivarán su inspiración para crear y transformar espacios habituales en ambientes verdaderamente cautivadores.



CONTENIDO

05 Línea led

- 08 Luminarias de acento
- 09 Luminarias de cortesía
- 22 Empotrados de cortesía
- 23 Empotrados para piso
- 25 Luminarias para jardín
- 29 Minipostes
- 33 Luminarias para muro
- 58 Luminarias solares
- 66 Luminarias para techo
- 70 Empotrados para techo
- 74 Sobreponer en techo
- 76 Lámparas

77 Línea empotrados

- 82 Sobreponer y empotrar
- 84 Yeso

85 Línea aluminio

- 87 Luminarias para muro
- 103 Luminarias para techo y muro
- 104 Minipostes

107 Línea inox

- 109 Luminarias para muro
- 113 Luminarias para muro y minipostes
- 115 Empotrar en piso

117 Línea productos para muro

- 123 Ónix
- 125 Luminarias de lectura
- 127 Barras

131 Línea plafones

- 134 Luminarias para techo

139 Línea productos para techo

- 141 Luminarias de sobreponer
- 144 Luminarias suspendidas

177 Candiles

- 179 Ónix
- 181 Forja
- 186 Satín

189 Fundición de aluminio y poste

- 191 Faroles
- 192 Postes

193 Cristal opalino

Bajo consumo energético,
mayor ahorro monetario.



Cuida el medio ambiente

Encendido instantáneo



No calienta el área iluminada

No emiten rayos UV



Larga vida útil

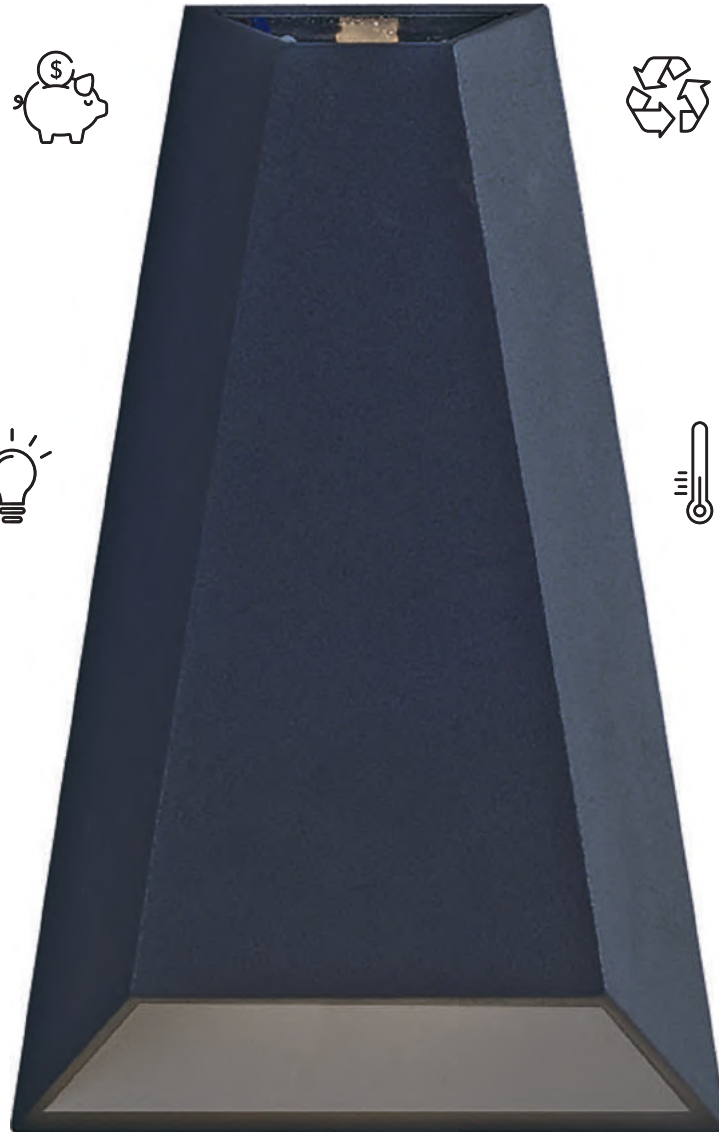

Los colores del área iluminada se ven
más radiantes y vivos

Iluminación a la medida

Siente el color

La temperatura de color se expresa en Kelvin, para el diseño de iluminación residencial nuestra recomendación como expertos es utilizar temperaturas que van desde 3,000 K (luz cálida) hasta 6,000 L (luz blanca). Una luz cálida nos dará la sensación de mayor confort y tranquilidad mientras que una luz blanca activa nuestros sentidos y brinda apoyo para la realización de tareas específicas.



¿Sabes que significa el IP?

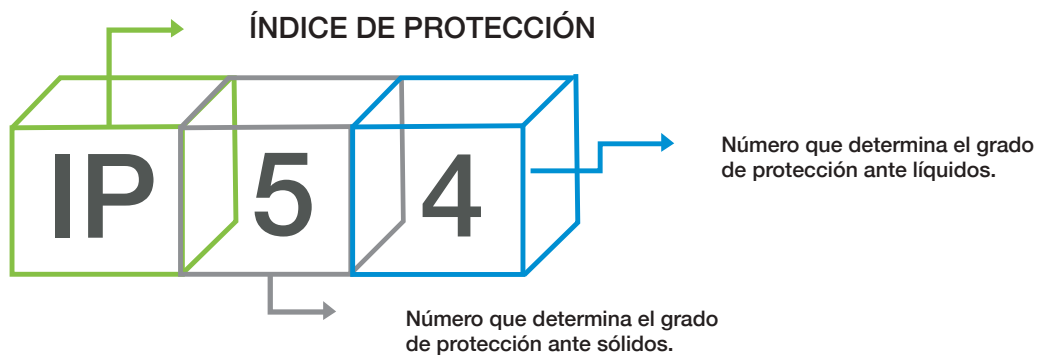

1ER DÍGITO: PROTECCIÓN ANTE SÓLIDOS	
0	Sin protección
1	Protección ante objetos de diámetro superior a 50 MM
2	Protección ante objetos de diámetro superior a 12 MM
3	Protección ante objetos con diámetro superior a 2.5 MM
4	Protección ante objetos con diámetro superior a 1 MM
5	Protegido contra ingreso limitado de polvo
6	Totalmente protegido contra el polvo

2DO DÍGITO : PROTECCIÓN ANTE LIQUIDOS	
0	Sin protección
1	Protección ante goteo vertical o condensación
2	Protección ante goteo con una inclinación de 15 grados
3	Protección ante goteo con una inclinación de 60 grados
4	Protección ante salpicaduras de gotas en todas direcciones
5	Protección ante chorros de agua a baja presión
6	Protección ante potentes y continuos chorros de agua
7	Protección ante inmersiones temporales
8	Protección ante inmersiones prolongadas o permanentes





LÍNEA LED

El núcleo que da luz a la convivencia

CALUX
ILUMINA MEJOR

CAMINOS RESPLANDECIENTES

Facilita a tus seres
queridos el encuentro
con tu hogar.

0120-LED



0120-LED/AZ



0220-LED

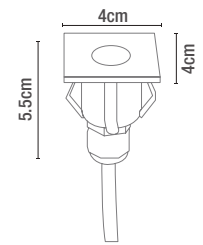
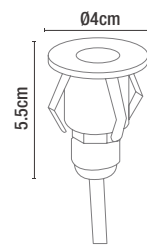
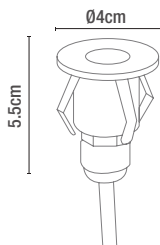

* LED COLOR AZUL



CÓDIGO	DESCRIPCIÓN	USO	MATERIA PRIMA	TERMINADO	POTENCIA MÁX (W)	VOLTAJE	VAC-Hz	IP	VIDA PROMEDIO (h)	ÁNGULO DE APERTURA	LUMENS	IRC (CRI)	TEMPERATURA (K)	CORTE DE EMPOTRAMIENTO
0120-LED	LUMINARIA LED PARA EMPOTRAR EN MURO O TECHO	EXTERIOR	ALUMINIO	ALUMINIO PULIDO	1 W	100-240 V~	50-60 Hz	65	40,000 h	20°	72 lm	80	3000 K	2 cm
0120-LED/AZ	LUMINARIA PARA EMPOTRAR CON LED AZUL PARA MURO O TECHO	EXTERIOR	ALUMINIO	ALUMINIO PULIDO	1 W	100-240 V~	50-60 Hz	65	40,000 h	20°	72 lm	80	ND	2 cm
0220-LED	LUMINARIA LED PARA EMPOTRAR EN MURO O TECHO	EXTERIOR	ALUMINIO	ALUMINIO PULIDO	1 W	100-240 V~	50-60 Hz	65	40,000 h	20°	72 lm	80	3000 K	2.5 cm

PRODUCTO NUEVO

4021-LED/GR

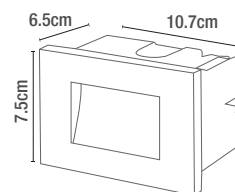

PRODUCTO NUEVO

4022-LED/GR

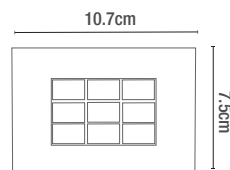

CÓDIGO	DESCRIPCIÓN	USO	MATERIA PRIMA	TERMINADO	POTENCIA MAX (W)	VOLTAJE	VAC-HZ	IP	VIDA PROMEDIO (HR)	ÁNGULO DE APERTURA	LUMENS	IRC (CRI)	TEMPERATURA (K)	CORTE DE EMPOTRAMIENTO
4021-LED/GR	LUMINARIA LED PARA EMPOTRAR EN MURO	EXTERIOR	ALUMINIO / POLICARBONATO	GRIS	4 W	100-240 V~	50-60 Hz	65	40,000 h	81°	180 lm	80	3000 K	9.7*6
4022-LED/GR	LUMINARIA LED PARA EMPOTRAR EN MURO	EXTERIOR	ALUMINIO / POLICARBONATO	GRIS	4 W	100-240 V~	50-60 Hz	65	40,000 h	61.9°	120 lm	80	3000 K	9.7*6

PRODUCTO
NUEVO

4024-LED/GR

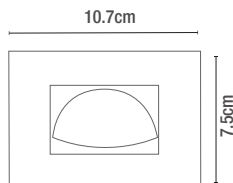
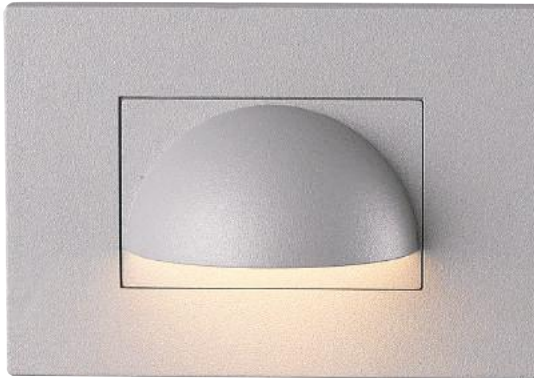

PRODUCTO
NUEVO

4023-LED/GR

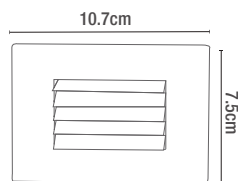

4024-LED/GR



CÓDIGO	DESCRIPCIÓN	USO	MATERIA PRIMA	TERMINADO	POTENCIA MÁX (W)	VOLTAJE	VAC-HZ	IP	VIDA PROMEDIO (HR)	ÁNGULO DE APERTURA	LUMENS	IRC (CRI)	TEMPERATURA (K)	CORTE DE EMPOTRAMIENTO
4024-LED/GR	LUMINARIA LED PARA EMPOTRAR EN MURO	EXTERIOR	ALUMINIO	GRIS	4 W	100-240 V~	50-60 Hz	65	40,000 h	29°	65 lm	80	3000 K	9.7*3
4023-LED/GR	LUMINARIA LED PARA EMPOTRAR EN MURO	EXTERIOR	ALUMINIO / POLICARBONATO	GRIS	4 W	100-240 V~	50-60 Hz	65	40,000 h	48°	65 lm	80	3000 K	9.7*3

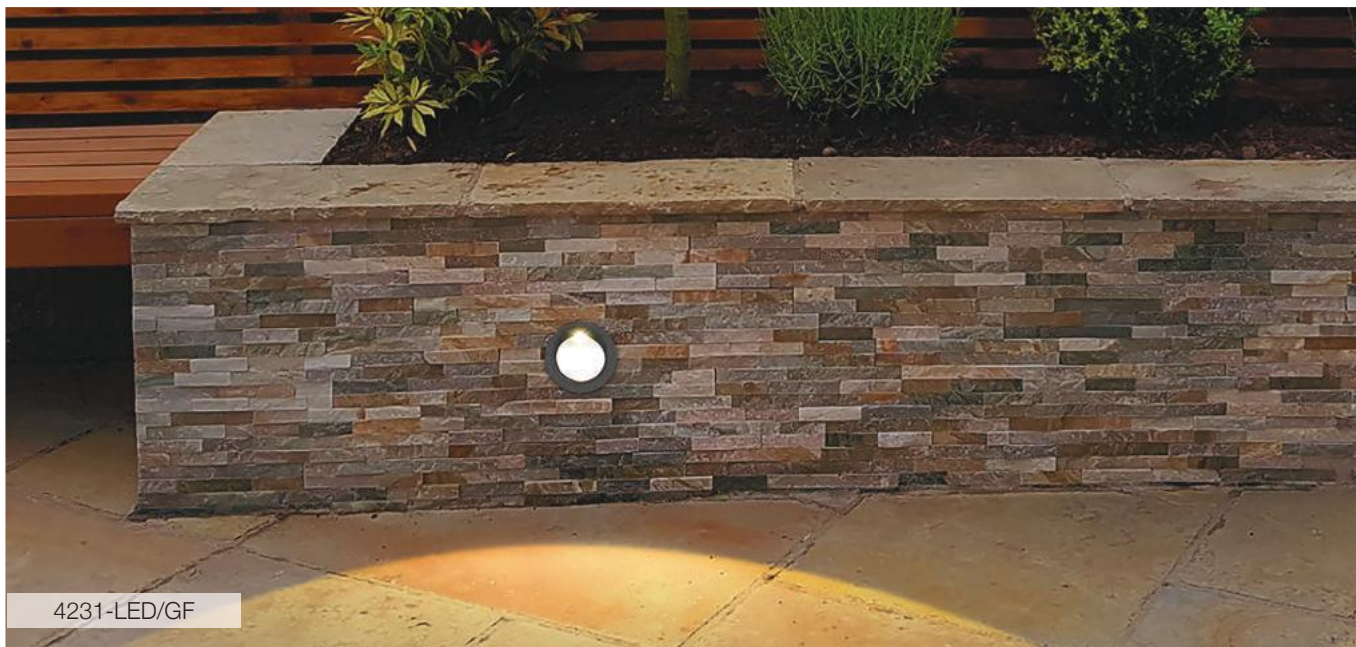

4231-LED/GF

4231-LED/GF

PRODUCTO NUEVO

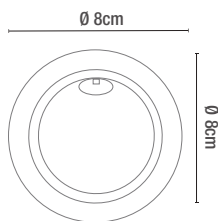

4232-LED/GF

PRODUCTO NUEVO

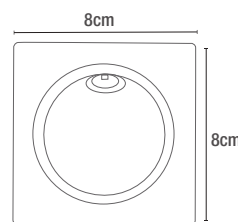

CÓDIGO	DESCRIPCIÓN	USO	MATERIA PRIMA	TERMINADO	POTENCIA MAX (W)	VOLTAJE	VAC-HZ	IP	VIDA PROMEDIO (HR)	ÁNGULO DE APERTURA	LUMENS	IRC (CRI)	TEMPERATURA (K)	CORTE DE EMPOTRAMIENTO
4231-LED/GF	LUMINARIA LED PARA EMPOTRAR EN MURO	EXTERIOR	ALUMINIO	GRAFITO	3 W	100-240 V~	50-60 Hz	54	40,000 h	73°	90 lm	80	3000 K	73.5 mm
4232-LED/GF	LUMINARIA LED PARA EMPOTRAR EN MURO	EXTERIOR	ALUMINIO	GRAFITO	3 W	100-240 V~	50-60 Hz	54	40,000 h	50°	100 lm	80	3000 K	73.5 mm



2220-LED

9020-LED

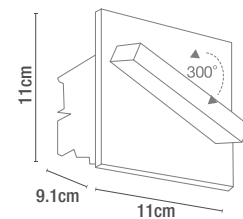
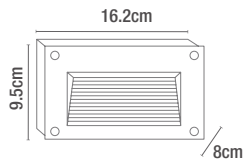

CÓDIGO	DESCRIPCIÓN	USO	MATERIA PRIMA	TERMINADO	POTENCIA MAX (W)	VOLTAJE	VAC-Hz	IP	VIDA PROMEDIO (h)	ÁNGULO DE APERTURA	LUMENS	IRC (CRI)	TEMPERATURA (K)	CORTE DE EMPOTRAMIENTO
2220-LED	LUMINARIA LED PARA EMPOTRAR EN MURO	EXTERIOR	ALUMINIO	GRIS	1.2 W	100-240 V~	50-60 Hz	54	40,000 h	100°	25 lm	80	3000 K	15.8 X 9.7 cm
9020-LED	LUMINARIA LED DIRIGIBLE PARA EMPOTRAR EN MURO	EXTERIOR	ALUMINIO	GRIS	3 W	100-240 V~	50-60 Hz	65	40,000 h	88°	240 lm	80	3000 K	9.7 X 6 cm

3520-LED

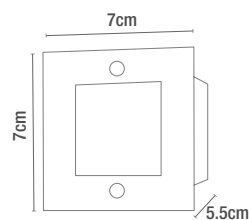

3620-LED

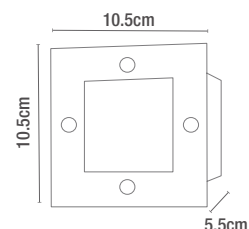

3720-LED

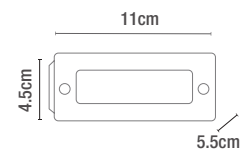

CÓDIGO	DESCRIPCIÓN	USO	MATERIA PRIMA	TERMINADO	POTENCIA MÁX (W)	VOLTAJE	VAC-Hz	IP	VIDA PROMEDIO (h)	ÁNGULO DE APERTURA	LUMENS	IRC (CRI)	TEMPERATURA (K)	CORTE DE EMPOTRAMIENTO
3520-LED	LUMINARIA LED PARA EMPOTRAR EN MURO	EXTERIOR	ACERO INOX	ACERO INOXIDABLE	0.9 W	100-130 V~	50-60 Hz	65	40,000 h	100°-110°	47 lm	80	3000 K	6.5 X 6.4 cm
3620-LED	LUMINARIA LED PARA EMPOTRAR EN MURO	EXTERIOR	ACERO INOX	ACERO INOXIDABLE	1.6 W	100-130 V~	50-60 Hz	65	40,000 h	100°-110°	70 lm	80	3000 K	9.5 X 9.5 cm
3720-LED	LUMINARIA LED PARA EMPOTRAR EN MURO	EXTERIOR	ACERO INOX	ACERO INOXIDABLE	1.2 W	100-130 V~	50-60 Hz	65	40,000 h	100°-110°	52 lm	80	3000 K	10.4 X 4 cm

3320-LED

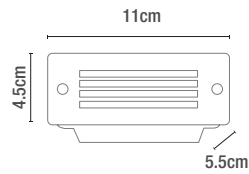

3420-LED

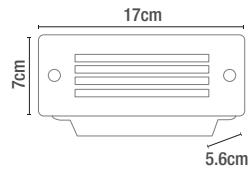

CÓDIGO	DESCRIPCIÓN	USO	MATERIA PRIMA	TERMINADO	POTENCIA MAX (W)	VOLTAJE	VAC-Hz	IP	VIDA PROMEDIO (h)	ÁNGULO DE APERTURA	LUMENS	IRC (CRI)	TEMPERATURA (K)	CORTE DE EMPOTRAMIENTO
3320-LED	LUMINARIA LED PARA EMPOTRAR EN MURO	EXTERIOR	ACERO INOX	ACERO INOXIDABLE	1.2 W	100-130 V~	50-60 Hz	65	40,000 h	100°-110°	52 lm	80	3000 K	10.4 X 4 cm
3420-LED	LUMINARIA LED PARA EMPOTRAR EN MURO	EXTERIOR	ACERO INOX	ACERO INOXIDABLE	1.6 W	100-130 V~	50-60 Hz	65	40,000 h	100°-110°	70 lm	80	3000 K	15.8 X 5.4 cm

DESTELLOS QUE INVITAN A PASAR

Embeliece la entrada
de tu sitio especial

4020-LED/G

4020-LED/G

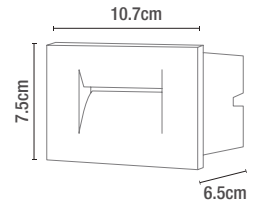
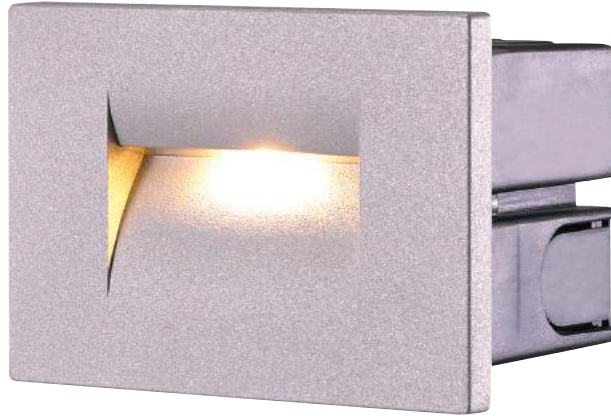

4120-LED/G

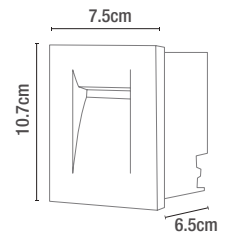

CÓDIGO	DESCRIPCIÓN	USO	MATERIA PRIMA	TERMINADO	POTENCIA MÁX (W)	VOLTAJE	VAC-Hz	IP	VIDA PROMEDIO (h)	ÁNGULO DE APERTURA	LUMENS	IRC (CRI)	TEMPERATURA (K)	CORTE DE EMPOTRAMIENTO
4020-LED/G 4020-LED/B	LUMINARIA LED PARA EMPOTRAR EN MURO	EXTERIOR	ALUMINIO	GRIS BLANCO	3.6 W	100-240 V~	50-60 Hz	65	40,000 h	33°	75 lm	80	3000 K	9.6 X 6 cm
4120-LED/G 4120-LED/B	LUMINARIA LED PARA EMPOTRAR EN MURO	EXTERIOR	ALUMINIO	GRIS BLANCO	3.6 W	100-240 V~	50-60 Hz	65	40,000 h	48°	99 lm	80	3000 K	6 X 9.5 cm



4230-LED/BL

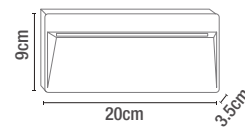
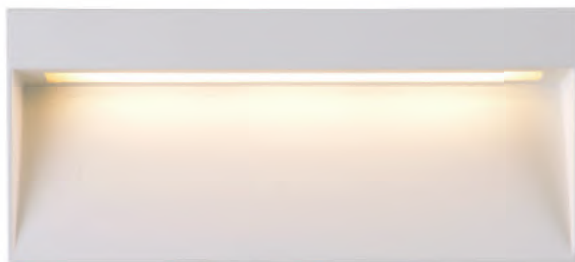

1712-LED/GR

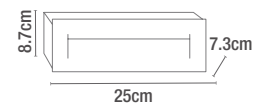
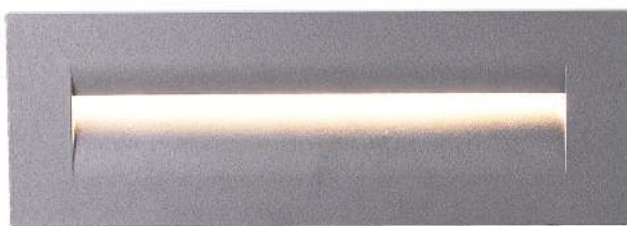

CÓDIGO	DESCRIPCIÓN	USO	MATERIA PRIMA	TERMINADO	POTENCIA MÁX (W)	VOLTAJE	VAC-Hz	IP	VIDA PROMEDIO (h)	ÁNGULO DE APERTURA	LUMENS	IRC (CRI)	TEMPERATURA (K)	CORTE DE EMPOTRAMIENTO
4230-LED/BL	LUMINARIA LED DE SOBREPONER EN MURO	EXTERIOR	ALUMINIO	BLANCO	9 W	100-240 V~	50-60 Hz	54	40,000 h	120°	238 lm	80	3000 K	N/A
1712-LED/GR	LUMINARIA LED PARA EMPOTRAR EN MURO	EXTERIOR	ALUMINIO	GRIS	8.5 W	100-240 V~	50-60 Hz	65	40,000 h	42°	190 lm	80	3000 K	7.3 X 23.8 cm



4720-LED

4721S-LED/GR

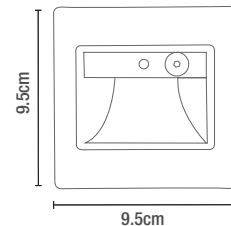
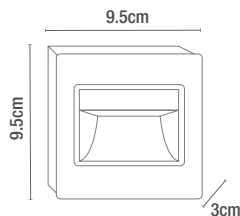

CÓDIGO	DESCRIPCIÓN	USO	MATERIA PRIMA	TERMINADO	POTENCIA MÁX (W)	VOLTAJE	VAC-Hz	IP	VIDA PROMEDIO (h)	ÁNGULO DE APERTURA	LUMENS	IRC (CRI)	TEMPERATURA (K)	CORTE DE EMPOTRAMIENTO
4720-LED/BL 4720-LED	LUMINARIA LED PARA EMPOTRAR EN MURO	INTERIOR	PLÁSTICO	BLANCO GRIS	1.2 W	100-240 V~	50-60 Hz	23	40,000 h	120°	25 lm	80	3000 K	8 X 8 cm
4721S-LED/BL 4721S-LED/GR	LUMINARIA LED PARA EMPOTRAR EN MURO	INTERIOR	PLÁSTICO	BLANCO GRIS	1.2 W	100-240 V~	50-60 Hz	23	40,000 h	120°	25 lm	80	3000 K	8 X 8 cm

FULGOR DE ALTURA

Enfatiza la belleza de
tu espacio



8920-LED/GR

4240-LED/BL

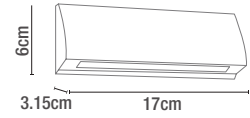

8920-LED/GR

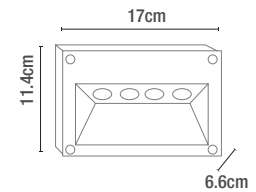

CÓDIGO	DESCRIPCIÓN	USO	MATERIA PRIMA	TERMINADO	POTENCIA MÁX (W)	VOLTAJE	VAC-Hz	IP	VIDA PROMEDIO (h)	ÁNGULO DE APERTURA	LUMENS	IRC (CRI)	TEMPERATURA (K)	CORTE DE EMPOTRAMIENTO
4240-LED/BL	LUMINARIA LED DE SOBREPONER EN MURO	EXTERIOR	ALUMINIO	BLANCO	6 W	100-240 V~	50-60 Hz	54	40,000 h	20°	360 lm	80	3000 K	NA
8920-LED/GR	LUMINARIA LED PARA EMPOTRAR EN MURO	EXTERIOR	ALUMINIO	GRIS	4 W	100-240 V~	50-60 Hz	65	40,000 h	31°	327 lm	80	3000 K	16.4 X 10.7 cm

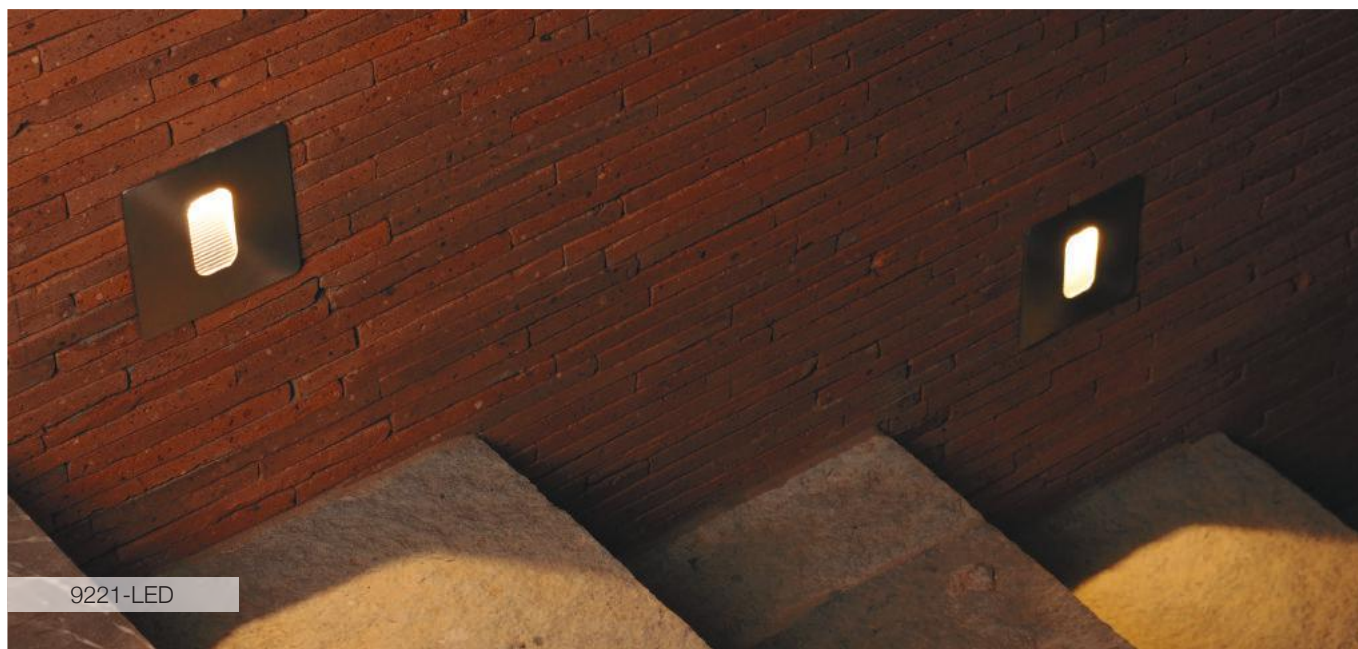

9221-LED

9220-LED

9221-LED

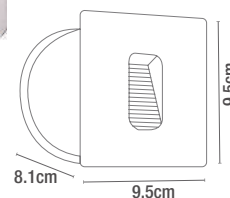
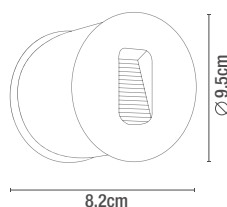

CÓDIGO	DESCRIPCIÓN	USO	MATERIA PRIMA	TERMINADO	POTENCIA MAX (W)	VOLTAJE	VAC-Hz	IP	VIDA PROMEDIO (h)	ÁNGULO DE APERTURA	LUMENS	IRC (CRI)	TEMPERATURA (K)	CORTE DE EMPOTRAMIENTO
9220-LED	LUMINARIA LED PARA EMPOTRAR EN MURO	EXTERIOR	ACERO INOX	ACERO INOXIDABLE	3 W	100-240 V~	50-60 Hz	65	40,000 h	62°	54 lm	80	3000 K	8.2 cm
9221-LED	LUMINARIA LED PARA EMPOTRAR EN MURO	EXTERIOR	ACERO INOX	ACERO INOXIDABLE	3 W	100-240 V~	50-60 Hz	65	40,000 h	62°	54 lm	80	3000 K	8.5 cm

7320-LED

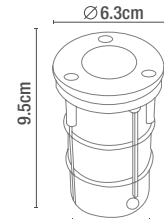

7020-LED

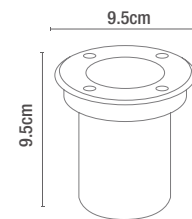

CÓDIGO	DESCRIPCIÓN	USO	MATERIA PRIMA	TERMINADO	POTENCIA MAX (W)	VOLTAJE	VAC-Hz	IP	VIDA PROMEDIO (h)	ÁNGULO DE APERTURA	LUMENS	IRC (CRI)	TEMPERATURA (K)	CORTE DE EMPOTRAMIENTO
7320-LED	LUMINARIA LED PARA EMPOTRAR EN PISO	EXTERIOR	ACERO INOX	ACERO INOXIDABLE	0.8 W	100-240 V~	50-60 Hz	65	40,000 h	N/A	21 lm	80	3000 K	5.9 cm
7020-LED	LUMINARIA LED PARA EMPOTRAR EN PISO	EXTERIOR	ACERO INOX	ACERO INOXIDABLE	1.2 W	100-240 V~	50-60 Hz	65	40,000 h	N/A	36 lm	80	3000 K	8.8 cm

8120-LED

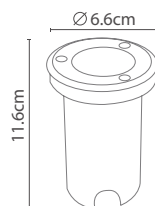

7120-LED

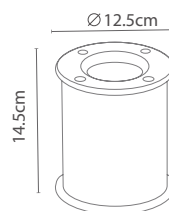

CÓDIGO	DESCRIPCIÓN	USO	MATERIA PRIMA	TERMINADO	POTENCIA MAX (W)	VOLTAJE	VAC-Hz	IP	VIDA PROMEDIO (h)	ÁNGULO DE APERTURA	LUMENS	IRC (CRI)	TEMPERATURA (K)	CORTE DE EMPOTRAMIENTO
8120-LED	LUMINARIA LED DIRIGIBLE PARA EMPOTRAR EN PISO	EXTERIOR	ACERO INOX	ACERO INOXIDABLE	1 W	100-240 V~	50-60 Hz	65	40,000 h	28°	68 lm	80	3000 K	6.3 cm
7120-LED	LUMINARIA LED DIRIGIBLE PARA EMPOTRAR EN PISO	EXTERIOR	ACERO INOX	ACERO INOXIDABLE	3 W	100-240 V~	50-60 Hz	65	40,000 h	25°	214 lm	80	3000 K	12.3 cm

5120-LED

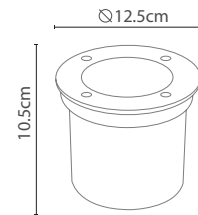

5020-LED

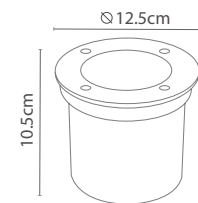

CÓDIGO	DESCRIPCIÓN	USO	MATERIA PRIMA	TERMINADO	POTENCIA MAX (W)	VOLTAJE	VAC-Hz	IP	VIDA PROMEDIO (h)	ÁNGULO DE APERTURA	LUMENS	IRC (CRI)	TEMPERATURA (K)	CORTE DE EMPOTRAMIENTO
5120-LED	LUMINARIA LED PARA EMPOTRAR EN PISO	EXTERIOR	ACERO INOX / CRISTAL	ACERO INOXIDABLE	6 W	100-240 V~	50-60 Hz	65	40,000 h	25°	426 lm	80	3000 K	10.8 cm
5020-LED	LUMINARIA LED PARA EMPOTRAR EN PISO	EXTERIOR	ACERO INOX / CRISTAL	ACERO INOXIDABLE	7 W	100-240 V~	50-60 Hz	65	40,000 h	110°	473 lm	80	3000 K	11 cm

0720-LED

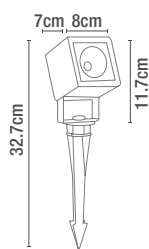

0920-LED/GF

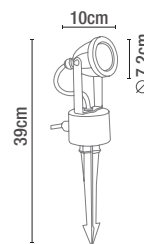

S6061-LED

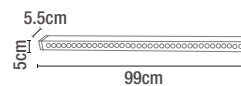

CÓDIGO	DESCRIPCIÓN	USO	MATERIA PRIMA	TERMINADO	POTENCIA MAX (W)	VOLTAJE	VAC-Hz	IP	VIDA PROMEDIO (h)	ÁNGULO DE APERTURA	LUMENS	IRC (CRI)	TEMPERATURA (K)
0720-LED	LUMINARIA LED PARA JARDIN CON ESTACA	EXTERIOR	ALUMINIO	GRAFITO	7 W	100-240 V~	50-60 Hz	65	40,000 h	39°	546 lm	80	3000 K
0920-LED/GF	LUMINARIA LED PARA JARDIN CON ESTACA	EXTERIOR	ALUMINIO	GRAFITO	7 W	100-240 V~	50-60 Hz	65	40,000 h	39°	400 lm	82	3000 K
S6061-LED	LUMINARIA LED PARA BAÑAR MURO	EXTERIOR	ALUMINIO	ALUMINIO	36 W	100-240 V~	50-60 Hz	54	40,000 h	N/A	2400 lm	80	3000 K

3020-LED

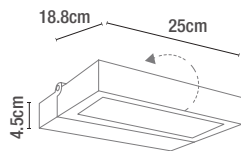

3021-LED

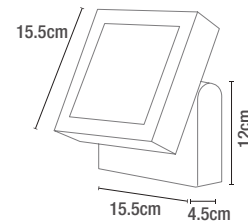

CL-2000S-LED/BL

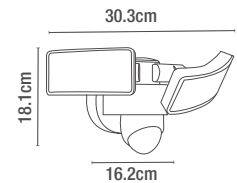

CÓDIGO	DESCRIPCIÓN	USO	MATERIA PRIMA	TERMINADO	POTENCIA MAX (W)	VOLTAJE	VAC-Hz	IP	VIDA PROMEDIO (h)	ÁNGULO DE APERTURA	LUMENS	IRC (CRI)	TEMPERATURA (K)
3020-LED	LUMINARIA LED DIRIGIBLE DE SOBREPONER EN TECHO, MURO O PISO	EXTERIOR	ALUMINIO / CRISTAL	GRAFITO	36 W	100-240 V~	50-60 Hz	65	40,000 h	28°	1964 lm	80	3000 K
3021-LED	LUMINARIA LED DE SOBREPONER EN TECHO, MURO O PISO	EXTERIOR	ALUMINIO / CRISTAL	GRAFITO	16 W	100-240 V~	50-60 Hz	65	40,000 h	45°	1001 lm	80	3000 K
CL-2000S-LED/BL	LUMINARIA REFLECTOR LED DIRIGIBLE CON SENSOR PARA MURO	EXTERIOR	POLICARBONATO	BLANCO	24 W	100-240 V~	50-60 Hz	65	40,000 h	100°	2200 lm	80	4 100 K

RF-3522-LED

PRODUCTO NUEVO

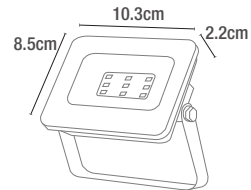

RF-3524-LED

PRODUCTO NUEVO

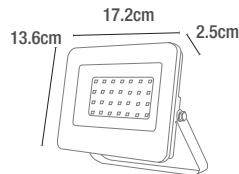

RF-3526-LED

PRODUCTO NUEVO

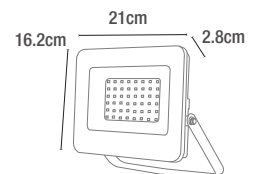

CÓDIGO	DESCRIPCIÓN	USO	MATERIA PRIMA	TERMINADO	POTENCIA MAX (W)	VOLTAJE	VAC-Hz	IP	VIDA PROMEDIO (h)	ÁNGULO DE APERTURA	LUMENS	IRC (CRI)	TEMPERATURA (K)
RF-3522-LED	LUMINARIA REFLECTOR LED PARA MURO O TECHO	EXTERIOR	ALUMINIO / CRISTAL	NEGRO	10 W	100 - 240 V~	50-60 Hz	65	40,000 h	120°	880 lm	70	4000 K
RF-3524-LED	LUMINARIA REFLECTOR LED PARA MURO O TECHO	EXTERIOR	ALUMINIO / CRISTAL	NEGRO	30 W	100 - 240 V~	50-60 Hz	65	40,000 h	120°	2743 lm	70	4000 K
RF-3526-LED	LUMINARIA REFLECTOR LED PARA MURO O TECHO	EXTERIOR	ALUMINIO / CRISTAL	NEGRO	50 W	100 - 240 V~	50-60 Hz	65	40,000 h	120°	4436 lm	70	4000 K



S4030-LED

S4010-LED

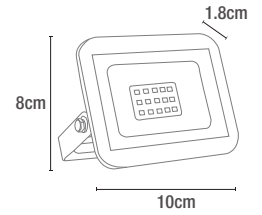

S4030-LED

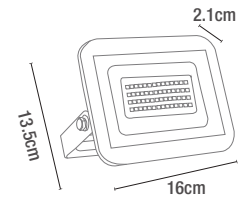

S4050-LED

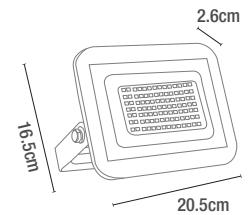

CÓDIGO	DESCRIPCIÓN	USO	MATERIA PRIMA	TERMINADO	POTENCIA MAX (W)	VOLTAJE	VAC-Hz	IP	VIDA PROMEDIO (h)	ÁNGULO DE APERTURA	LUMENS	IRC (CRI)	TEMPERATURA (K)
S4010-LED	LUMINARIA REFLECTOR LED PARA MURO O TECHO	EXTERIOR	ALUMINIO / CRISTAL	GRAFITO	10 W	110-130 V~	50-60 Hz	65	40,000 h	120°	750 lm	80	4000 K
S4030-LED	LUMINARIA REFLECTOR LED PARA MURO O TECHO	EXTERIOR	ALUMINIO / CRISTAL	GRAFITO	30 W	110-130 V~	50-60 Hz	65	40,000 h	120°	2250 lm	80	4000 K
S4050-LED	LUMINARIA REFLECTOR LED PARA MURO O TECHO	EXTERIOR	ALUMINIO / CRISTAL	GRAFITO	50 W	110-130 V~	50-60 Hz	65	40,000 h	120°	3750 lm	80	4000 K

0860-LED/GR

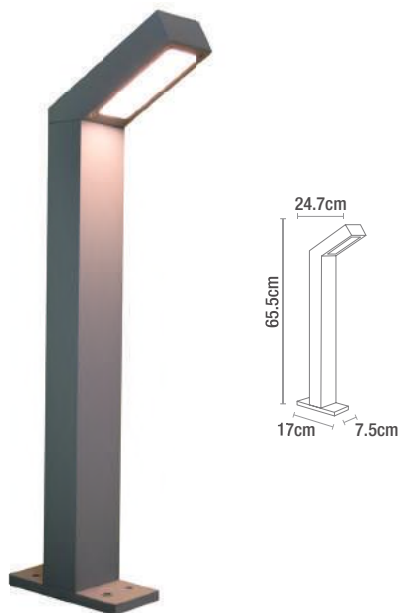

0861-LED/GF

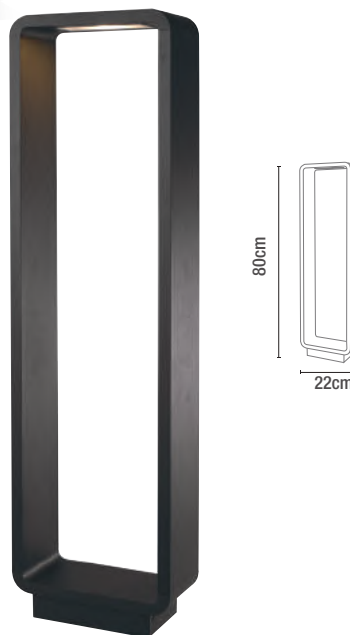

CÓDIGO	DESCRIPCIÓN	USO	MATERIA PRIMA	TERMINADO	POTENCIA MÁX (W)	VOLTAJE	VAC-Hz	IP	VIDA PROMEDIO (h)	ÁNGULO DE APERTURA	LUMENS	IRC (CRI)	TEMPERATURA (K)
0860-LED/GR	MINI POSTE DE LED	EXTERIOR	ALUMINIO	GRIS	9 W	100-240 V~	50-60 Hz	54	40,000 h	79°	210 lm	80	3000 K
0861-LED/GF	MINI POSTE DE LED	EXTERIOR	ALUMINIO	GRAFITO	10 W	100-130 V~	50-60 Hz	54	40,000 h	51 °	645 lm	80	3000 K

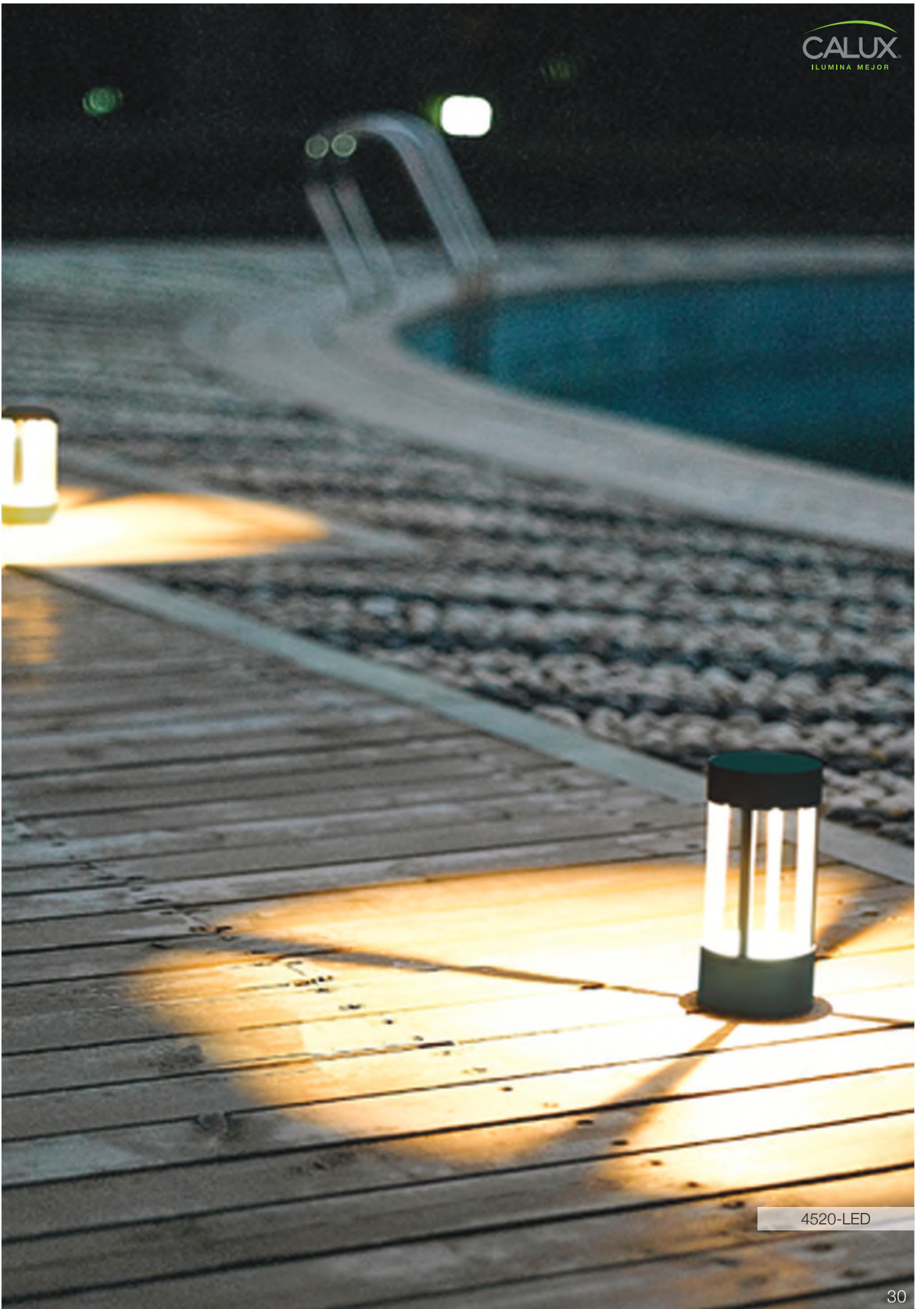

4520-LED

4520-LED

4620-LED

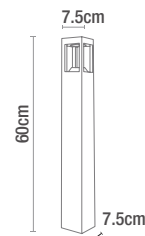
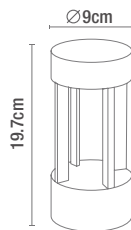

CÓDIGO	DESCRIPCIÓN	USO	MATERIA PRIMA	TERMINADO	POTENCIA MAX (W)	VOLTAJE	VAC-Hz	IP	VIDA PROMEDIO (h)	ÁNGULO DE APERTURA	LUMENS	IRC (CRI)	TEMPERATURA (K)
4520-LED	MINI POSTE LED DE SOBREPONER EN PISO	EXTERIOR	ALUMINIO	GRAFITO	7 W	100-240 V~	50-60 Hz	54	40,000 h	41°	419 lm	80	3000 K
4620-LED	MINI POSTE DE LED	EXTERIOR	ALUMINIO	GRAFITO	7 W	100-240 V~	50-60 Hz	54	40,000 h	43°	400 lm	80	3000 K

4820-LED

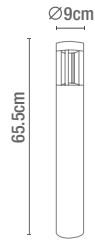

4920-LED

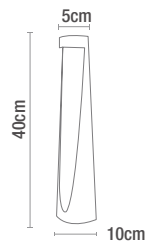

4920-LED



CÓDIGO	DESCRIPCIÓN	USO	MATERIA PRIMA	TERMINADO	POTENCIA MÁX (W)	VOLTAJE	VAC-Hz	IP	VIDA PROMEDIO (h)	ÁNGULO DE APERTURA	LUMENS	IRC (CRI)	TEMPERATURA (K)
4820-LED	MINI POSTE DE LED	EXTERIOR	ALUMINIO	GRAFITO	7 W	100-240 V~	50-60 Hz	54	40,000 h	41°	462 lm	80	3000 K
4920-LED	MINI POSTE DE LED	EXTERIOR	ALUMINIO	GRAFITO	7 W	100-240 V~	50-60 Hz	65	40,000 h	50°	350 lm	80	3000 K



7420-LED

1020-LED/GF

7420-LED

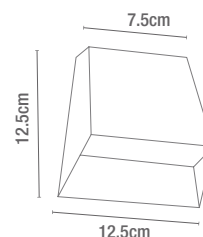
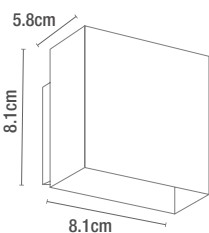
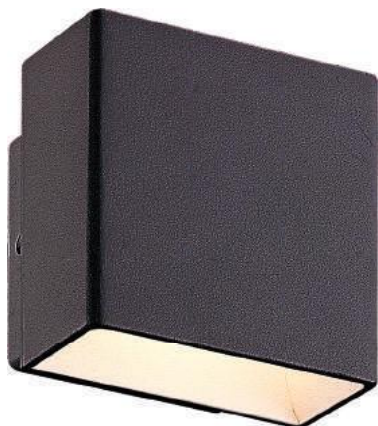

CÓDIGO	DESCRIPCIÓN	USO	MATERIA PRIMA	TERMINADO	POTENCIA MÁX (W)	VOLTAJE	VAC-Hz	IP	VIDA PROMEDIO (h)	ÁNGULO DE APERTURA	LUMENS	IRC (CRI)	TEMPERATURA (K)
1020-LED/GF	LUMINARIA LED PARA SOBREPONER EN MURO	EXTERIOR	ALUMINIO	GRAFITO	7 W	100-130 V~	50-60 Hz	54	40,000 h	93°	218 lm	80	3000 K
7420-LED	LUMINARIA LED PARA SOBREPONER EN MURO	EXTERIOR	ALUMINIO	GRAFITO	7 W	100-240 V~	50-60 Hz	54	40,000 h	108°	389 lm	80	3000 K

1120-LED/GR

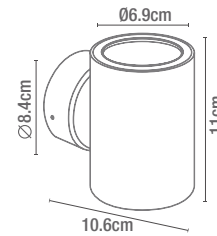

1420-LED/GR

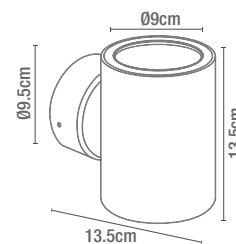

CÓDIGO	DESCRIPCIÓN	USO	MATERIA PRIMA	TERMINADO	POTENCIA MÁX (W)	VOLTAJE	VAC-Hz	IP	VIDA PROMEDIO (h)	ÁNGULO DE APERTURA	LUMENS	IRC (CRI)	TEMPERATURA (K)
1120-LED/GF	LUMINARIA LED PARA SOBREPONER EN MURO	EXTERIOR	ALUMINIO	GRAFITO	8 W	100-240 V~	50-60 Hz	54	40,000 h	44°	575 lm	80	3000 K
1120-LED/GR	LUMINARIA LED PARA SOBREPONER EN MURO	EXTERIOR	ALUMINIO	GRIS	8 W	100-240 V~	50-60 Hz	54	40,000 h	44°	575 lm	80	3000 K
1420-LED/GR	LUMINARIA LED PARA SOBREPONER EN MURO	EXTERIOR	ALUMINIO	GRIS	14 W	100-240 V~	50-60 Hz	54	40,000 h	18°	1153 lm	80	3000 K

1220-LED/GF

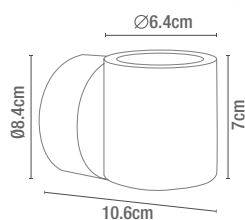

1520-LED/GR

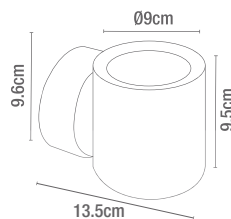

1220-LED/GR



CÓDIGO	DESCRIPCIÓN	USO	MATERIA PRIMA	TERMINADO	POTENCIA MAX (W)	VOLTAJE	VAC-Hz	IP	VIDA PROMEDIO (h)	ÁNGULO DE APERTURA	LUMENS	IRC (CRI)	TEMPERATURA (K)
1220-LED/GF	LUMINARIA LED PARA SOBREPONER EN MURO	EXTERIOR	ALUMINIO	GRAFITO	4 W	100-240 V~	50-60 Hz	54	40,000 h	36°	302 lm	80	3000 K
1220-LED/GR	LUMINARIA LED PARA SOBREPONER EN MURO	EXTERIOR	ALUMINIO	GRIS	4 W	100-240 V~	50-60 Hz	54	40,000 h	36°	302 lm	80	3000 K
1520-LED/GR	LUMINARIA LED PARA SOBREPONER EN MURO	EXTERIOR	ALUMINIO	GRIS	7 W	100-240 V~	50-60 Hz	54	40,000 h	18°	540 lm	80	3000 K



1620-LED/GF

1620-LED/GF



8620-LED/GF

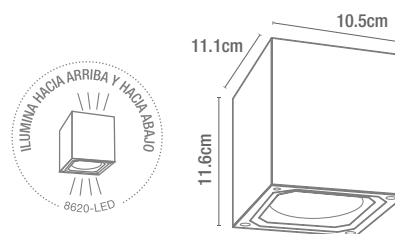
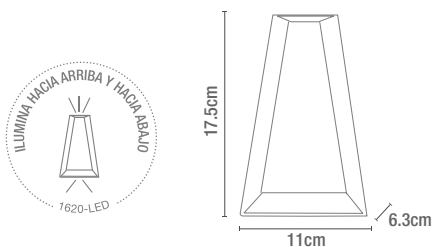

CÓDIGO	DESCRIPCIÓN	USO	MATERIA PRIMA	TERMINADO	POTENCIA MÁX (W)	VOLTAJE	VAC-Hz	IP	VIDA PROMEDIO (h)	ÁNGULO DE APERTURA	LUMENS	IRC (CRI)	TEMPERATURA (K)
1620-LED/GF				GRAFITO									
1620-LED/GR	LUMINARIA LED PARA SOBREPONER EN MURO	EXTERIOR	ALUMINIO	GRIS	6 W	100-240 V~	50-60 Hz	54	40,000 h	83°	62 lm	80	3000 K
1620-LED/B				BLANCO									
8620-LED/GF	LUMINARIA LED PARA SOBREPONER EN MURO	EXTERIOR	ALUMINIO	GRAFITO	12 W	100-240 V~	50-60 Hz	54	40,000 h	24°	1093 lm	80	3000 K
8620-LED/GR				GRIS									

9520-LED

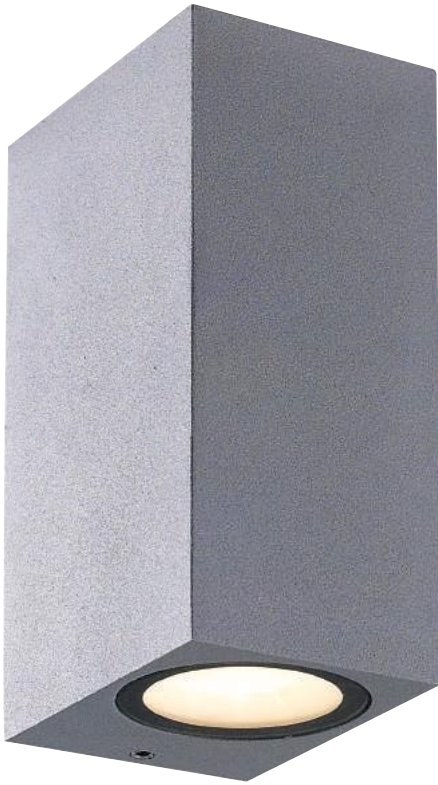

1720-LED/GR

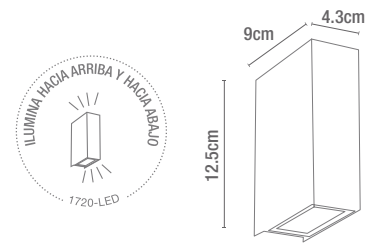
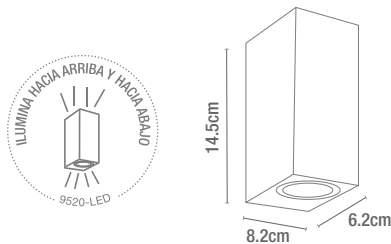

CÓDIGO	DESCRIPCIÓN	USO	MATERIA PRIMA	TERMINADO	POTENCIA MÁX (W)	VOLTAJE	VAC-Hz	IP	VIDA PROMEDIO (h)	ÁNGULO DE APERTURA	LUMENS	IRC (CRI)	TEMPERATURA (K)
9520-LED	LUMINARIA LED PARA SOBREPONER EN MURO	EXTERIOR	ALUMINIO	GRIS	14 W	100-240 V~	50-60 Hz	54	40,000 h	73°	928 lm	80	3000 K
1720-LED/GR	LUMINARIA LED PARA SOBREPONER EN MURO	EXTERIOR	ALUMINIO	GRIS	6 W	100-240 V~	50-60 Hz	54	40,000 h	65°	122 lm	80	3000 K



2520-LED/B

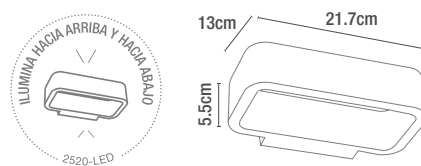

2620-LED

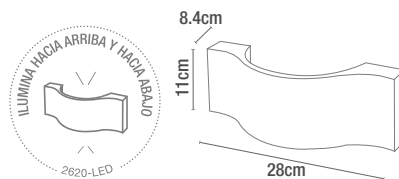

2520-LED/B



CÓDIGO	DESCRIPCIÓN	USO	MATERIA PRIMA	TERMINADO	POTENCIA MÁX (W)	VOLTAJE	VAC-Hz	IP	VIDA PROMEDIO (h)	ÁNGULO DE APERTURA	LUMENS	IRC (CRI)	TEMPERATURA (K)
2520-LED/B	LUMINARIA LED PARA SOBREPONER EN MURO	EXTERIOR	ALUMINIO	BLANCO	7 W	100-240 V~	50-60 Hz	54	40,000 h	126°	448 lm	80	3000 K
2520-LED	LUMINARIA LED PARA SOBREPONER EN MURO	EXTERIOR	ALUMINIO	GRIS	7 W	100-240 V~	50-60 Hz	54	40,000 h	126°	448 lm	80	3000 K
2620-LED	LUMINARIA LED PARA SOBREPONER EN MURO	EXTERIOR	ALUMINIO	GRAFITO	7 W	100-240 V~	50-60 Hz	54	40,000 h	100°	457 lm	80	3000 K



2820-LED

2820-LED

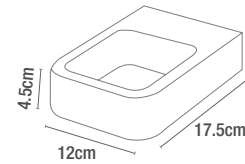

8820-LED

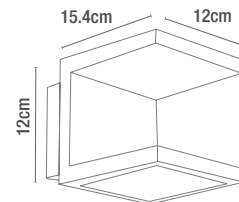

CÓDIGO	DESCRIPCIÓN	USO	MATERIA PRIMA	TERMINADO	POTENCIA MÁX (W)	VOLTAJE	VAC-Hz	IP	VIDA PROMEDIO (h)	ÁNGULO DE APERTURA	LUMENS	IRC (CRI)	TEMPERATURA (K)
2820-LED	LUMINARIA LED PARA SOBREPONER EN MURO	EXTERIOR	ALUMINIO	GRAFITO	7 W	100-240 V~	50-60 Hz	54	40,000 h	160°	290 lm	80	3000 K
8820-LED	LUMINARIA LED PARA SOBREPONER EN MURO	EXTERIOR	ALUMINIO/ACRÍLICO	GRAFITO	15 W	100-240 V~	50-60 Hz	54	40,000 h	110°	491 lm	80	3000 K

9320-LED/GF



2920-LED

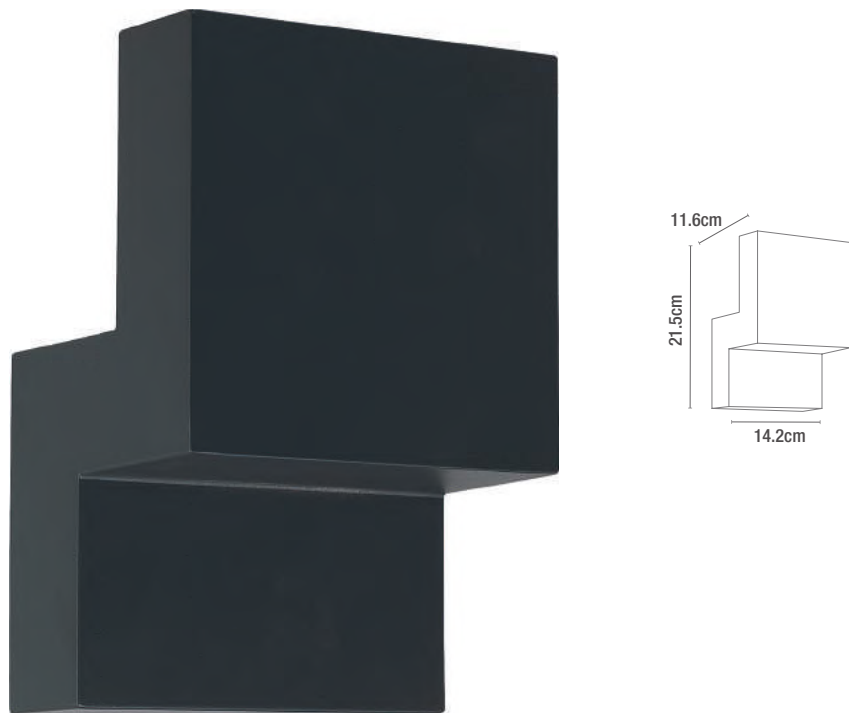

CÓDIGO	DESCRIPCIÓN	USO	MATERIA PRIMA	TERMINADO	POTENCIA MÁX (W)	VOLTAJE	VAC-Hz	IP	VIDA PROMEDIO (h)	ÁNGULO DE APERTURA	LUMENS	IRC (CRI)	TEMPERATURA (K)
9320-LED/GF	LUMINARIA LED PARA SOBREPONER EN MURO	EXTERIOR	ALUMINIO	GRAFITO	7 W	100-240 V~	50-60 Hz	54	40,000 h	25°	538 lm	80	3000 K
2920-LED	LUMINARIA LED PARA SOBREPONER EN MURO	EXTERIOR	ALUMINIO	GRAFITO	12 W	100-240 V~	50-60 Hz	54	40,000 h	64°	366 lm	80	3000 K

3023-LED

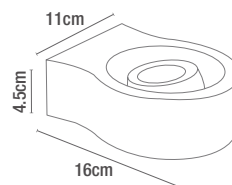

4420-LED

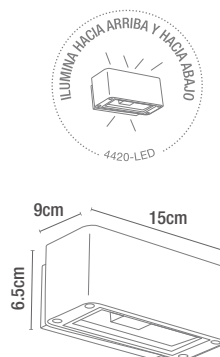

CÓDIGO	DESCRIPCIÓN	USO	MATERIA PRIMA	TERMINADO	POTENCIA MÁX (W)	VOLTAJE	VAC-Hz	IP	VIDA PROMEDIO (h)	ÁNGULO DE APERTURA	LUMENS	IRC (CRI)	TEMPERATURA (K)
3023-LED	LUMINARIA LED DIRIGIBLE PARA SOBREPONER EN MURO	EXTERIOR	ALUMINIO / CRISTAL	GRAFITO	6 W	100-240 V~	50-60 Hz	54	40,000 h	24°	218 lm	80	3000 K
4420-LED	LUMINARIA LED PARA SOBREPONER EN MURO	EXTERIOR	ALUMINIO / CRISTAL	GRAFITO	12 W	100-240 V~	50-60 Hz	54	40,000 h	102°	400 lm	80	3000 K

3022-LED

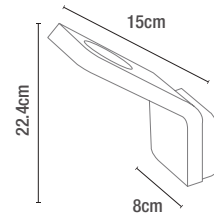

4320-LED

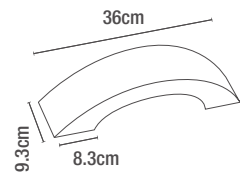

CÓDIGO	DESCRIPCIÓN	USO	MATERIA PRIMA	TERMINADO	POTENCIA MÁX (W)	VOLTAJE	VAC-Hz	IP	VIDA PROMEDIO (h)	ÁNGULO DE APERTURA	LUMENS	IRC (CRI)	TEMPERATURA (K)
3022-LED	LUMINARIA LED PARA SOBREPONER EN MURO	EXTERIOR	ALUMINIO	GRAFITO	7 W	100-240 V~	50-60 Hz	54	40,000 h	107°	296 lm	84	3000 K
4320-LED	LUMINARIA LED PARA SOBREPONER EN MURO	EXTERIOR	ALUMINIO	GRIS	9 W	100-240 V~	50-60 Hz	54	40,000 h	100°	238 lm	85	3000 K

5420-LED/GF

PRODUCTO
NUEVO

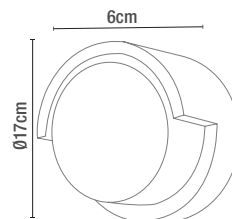

1025-LED/GF

PRODUCTO
NUEVO

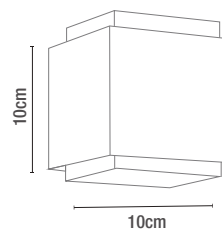

CÓDIGO	DESCRIPCIÓN	USO	MATERIA PRIMA	TERMINADO	POTENCIA MÁX (W)	VOLTAJE	VAC-Hz	IP	VIDA PROMEDIO (h)	ÁNGULO DE APERTURA	LUMENS	IRC (CRI)	TEMPERATURA (K)
5420-LED/GF	LUMINARIA LED PARA SOBREPONER EN MURO	EXTERIOR	ALUMINIO / POLICARBONATO	GRAFITO	9.6 W	100-240 V~	50-60 Hz	54	40,000 h	120°	420 lm	80	3000 K
1025-LED/GF	LUMINARIA LED PARA SOBREPONER EN MURO	EXTERIOR	ALUMINIO / CRISTAL	GRAFITO	12 W	100-240 V~	50-60 Hz	54	40,000 h	172°	170 lm	80	3000 K

2720-LED



3820-LED/GF

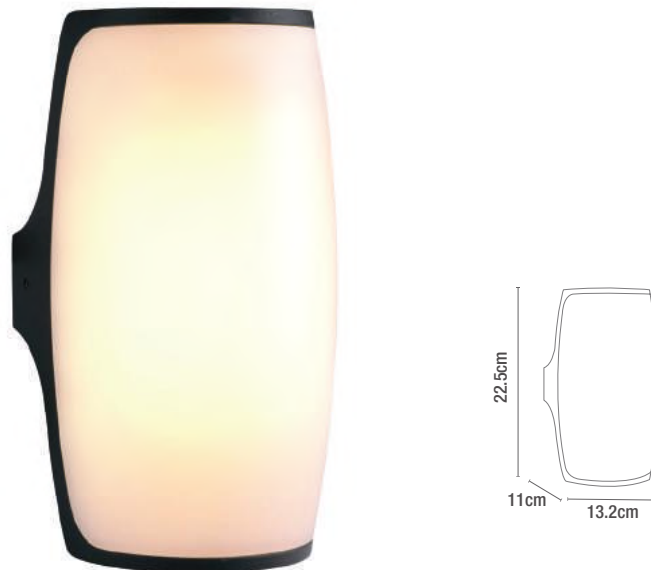

CÓDIGO	DESCRIPCIÓN	USO	MATERIA PRIMA	TERMINADO	POTENCIA MÁX (W)	VOLTAJE	VAC-Hz	IP	VIDA PROMEDIO (h)	ÁNGULO DE APERTURA	LUMENS	IRC (CRI)	TEMPERATURA (K)
2720-LED	LUMINARIA LED PARA SOBREPONER EN MURO Y TECHO	EXTERIOR	ALUMINIO / POLICARBONATO	GRIS	18 W	100-240 V~	50-60 Hz	54	40,000 h	106°	1250 lm	80	3000 K
3820-LED/GF	LUMINARIA LED PARA SOBREPONER EN MURO	EXTERIOR	ALUMINIO / POLICARBONATO	GRAFITO	12 W	100-240 V~	50-60 Hz	54	40,000 h	180°	800 lm	80	3000 K

5320-LED/GF

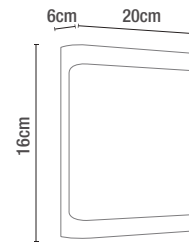

5220-LED/GF

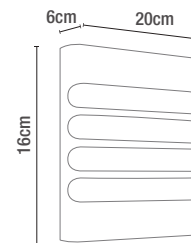

CÓDIGO	DESCRIPCIÓN	USO	MATERIA PRIMA	TERMINADO	POTENCIA MÁX (W)	VOLTAJE	VAC-Hz	IP	VIDA PROMEDIO (h)	ÁNGULO DE APERTURA	LUMENS	IRC (CRI)	TEMPERATURA (K)
5320-LED/GF	LUMINARIA LED PARA SOBREPONER EN MURO	EXTERIOR	ALUMINIO / POLICARBONATO	GRAFITO	10 W	100-240 V~	50-60 Hz	54	40,000 h	120°	750 lm	80	3000 K
5220-LED/GF	LUMINARIA LED PARA SOBREPONER EN MURO	EXTERIOR	ALUMINIO / POLICARBONATO	GRAFITO	9 W	100-240 V~	50-60 Hz	54	40,000 h	120°	232 lm	80	3000 K



5721-LED/BL

5225-LED/GF

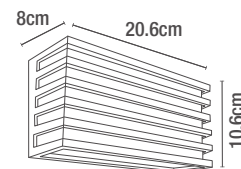
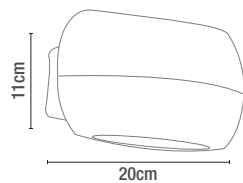

CÓDIGO	DESCRIPCIÓN	USO	MATERIA PRIMA	TERMINADO	POTENCIA MÁX (W)	VOLTAJE	VAC-Hz	IP	VIDA PROMEDIO (h)	ÁNGULO DE APERTURA	LUMENS	IRC (CRI)	TEMPERATURA (K)
5721-LED/BL	LUMINARIA LED DE SOBREPONER EN MURO	EXTERIOR	ALUMINIO	BLANCO	12 W	100-240 V~	50-60 Hz	54	40,000 h	90°	610 lm	80	3000 K
5225-LED/GF	LUMINARIA LED DE SOBREPONER EN MURO	EXTERIOR	ALUMINIO / ACRILICO	GRAFITO	10 W	100-240 V~	50-60 Hz	65	40,000 h	138°	315 lm	80	4000 K



4550-LED/GF

5226-LED/GF

4550-LED/GF



*PRODUCTO DIRIGIBLE

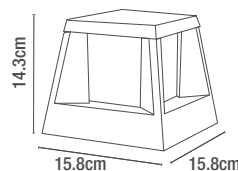
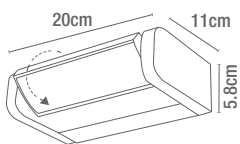

CÓDIGO	DESCRIPCIÓN	USO	MATERIA PRIMA	TERMINADO	POTENCIA MÁX (W)	VOLTAJE	VAC-Hz	IP	VIDA PROMEDIO (h)	ÁNGULO DE APERTURA	LUMENS	IRC (CRI)	TEMPERATURA (K)
5226-LED/GF	LUMINARIA LED DE SOBREPONER EN MURO	EXTERIOR	ALUMINIO / PLASTICO	GRAFITO	6 W	100-240 V~	50-60 Hz	65	40,000 h	138°	382 lm	80	3 000 K
4550-LED/GF	LUMINARIA LED DE SOBREPONER EN MURO	EXTERIOR	ALUMINIO / ACRILICO	GRAFITO	8 W	100-240 V~	50-60 Hz	65	40,000 h	350°	275 lm	80	4 000 K



5620-LED

5520-LED

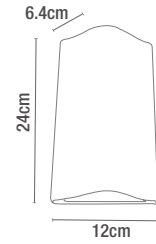

5620-LED

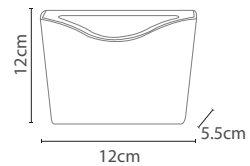

CÓDIGO	DESCRIPCIÓN	USO	MATERIA PRIMA	TERMINADO	POTENCIA MÁX (W)	VOLTAJE	VAC-Hz	IP	VIDA PROMEDIO (h)	ÁNGULO DE APERTURA	LUMENS	IRC (CRI)	TEMPERATURA (K)
5520-LED	LUMINARIA LED DE SOBREPONER EN MURO	EXTERIOR	ALUMINIO	GRAFITO	14 W	100-240 V~	50-60 Hz	54	40,000 h	98°	990 lm	82	3000 K
5620-LED	LUMINARIA LED DE SOBREPONER EN MURO	EXTERIOR	ALUMINIO	GRAFITO	7 W	100-240 V~	50-60 Hz	54	40,000 h	98°	377 lm	82	3000 K



9620-LED

9620-LED

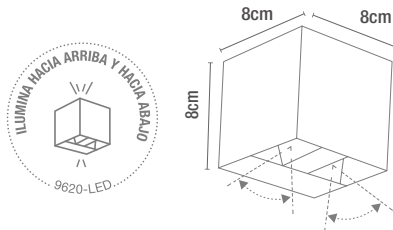

Ajustable

8720-LED/GF

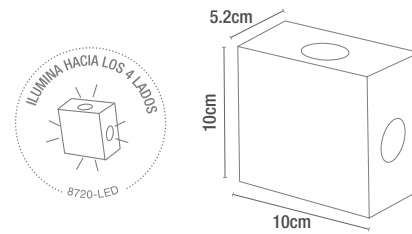

CÓDIGO	DESCRIPCIÓN	USO	MATERIA PRIMA	TERMINADO	POTENCIA MÁX (W)	VOLTAJE	VAC-Hz	IP	VIDA PROMEDIO (h)	ÁNGULO DE APERTURA	LUMENS	IRC (CRI)	TEMPERATURA (K)
9620-LED	LUMINARIA LED PARA MURO CON ANGULO DE APERTURA AJUSTABLE	EXTERIOR	ALUMINIO	GRAFITO	6 W	100-240 V~	50-60 Hz	54	40,000 h	30°-100°	360 lm	80	3000 K
8720-LED/GF	LUMINARIA LED DE SOBREPONER EN MURO	EXTERIOR	ALUMINIO	GRAFITO	4 W	100-240 V~	50-60 Hz	54	40,000 h	11°	321 lm	80	3000 K
8720-LED/GR				GRIS									



8320-LED/GF

8420-LED/GF

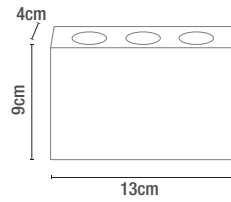

8320-LED/GF

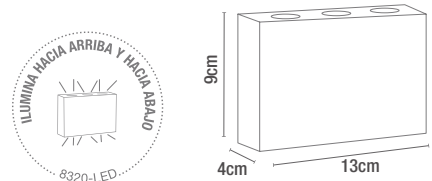

CÓDIGO	DESCRIPCIÓN	USO	MATERIA PRIMA	TERMINADO	POTENCIA MÁX (W)	VOLTAJE	VAC-Hz	IP	VIDA PROMEDIO (h)	ÁNGULO DE APERTURA	LUMENS	IRC (CRI)	TEMPERATURA (K)
8420-LED/GF	LUMINARIA LED DE SOBREPONER EN MURO	EXTERIOR	ALUMINIO	GRAFITO	3 W	100-240 V~	50-60 Hz	54	40,000 h	36°	280 lm	80	3000 K
8420-LED/GR				GRIS									
8320-LED/GF	LUMINARIA LED DE SOBREPONER EN MURO	EXTERIOR	ALUMINIO	GRAFITO	6 W	100-240 V~	50-60 Hz	54	40,000 h	36°	438 lm	80	3000 K
8320-LED/GR				GRIS									
8320-LED/B				BLANCO									

8520-LED

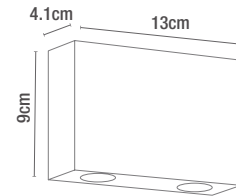

8521-LED

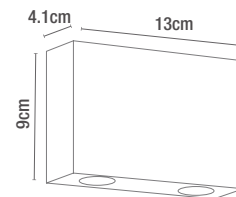

CÓDIGO	DESCRIPCIÓN	USO	MATERIA PRIMA	TERMINADO	POTENCIA MÁX (W)	VOLTAJE	VAC-Hz	IP	VIDA PROMEDIO (h)	ÁNGULO DE APERTURA	LUMENS	IRC (CRI)	TEMPERATURA (K)
8520-LED	LUMINARIA LED DE SOBREPONER EN MURO	EXTERIOR	ALUMINIO	GRAFITO	4 W	100-240 V~	50-60 Hz	54	40,000 h	34°	327 lm	80	3000 K
8521-LED	LUMINARIA LED DE SOBREPONER EN MURO	EXTERIOR	ALUMINIO	GRAFITO	2 W	100-240 V~	50-60 Hz	54	40,000 h	34°	181 lm	80	3000 K

CL-4000-LED/BL

PRODUCTO
NUEVO

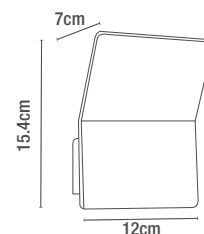

3920-LED/BL

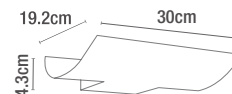

CÓDIGO	DESCRIPCIÓN	USO	MATERIA PRIMA	TERMINADO	POTENCIA MAX (W)	VOLTAJE	VAC-Hz	IP	VIDA PROMEDIO (h)	ÁNGULO DE APERTURA	LUMENS	IRC (CRI)	TEMPERATURA (K)
CL-4000-LED/BL	LUMINARIA LED DE SOBREPONER EN MURO	INTERIOR	ALUMINIO	BLANCO	8 W	100-240 V~	50-60 Hz	20	40,000 h	120°	795 lm	80	3000 K
3920-LED/BL	LUMINARIA LED DE SOBREPONER EN MURO	EXTERIOR	ALUMINIO	BLANCO	15 W	100-130 V~	50-60 Hz	54	40,000 h	98°	1151 lm	82	3000 K

1026-LED/GF

PRODUCTO
NUEVO

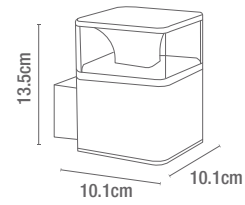

1027-LED/BL

PRODUCTO
NUEVO

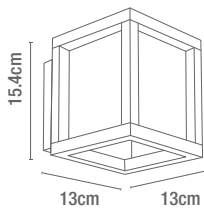

1028-LED/BL

PRODUCTO
NUEVO

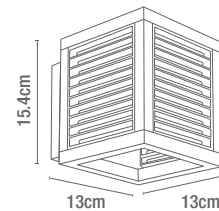

CÓDIGO	DESCRIPCIÓN	USO	MATERIA PRIMA	TERMINADO	POTENCIA MÁX (W)	VOLTAJE	VAC-Hz	IP	VIDA PROMEDIO (h)	ÁNGULO DE APERTURA	LUMENS	IRC (CRI)	TEMPERATURA (K)
1026-LED/GF	LUMINARIA LED DE SOBREPONER EN MURO	EXTERIOR	ALUMINIO/ POLICARBONATO	GRAFITO	6 w	100-240 V~	50-60 Hz	65	40,000 h	360°	389 lm	80	3,000 K
1027-LED/BL	LUMINARIA DE SOBREPONER EN MURO	EXTERIOR	ALUMINIO	BLANCO	10 w	100-240 V~	50-60 Hz	54	40,000 h	180°	996 lm	80	3,000 K
1028-LED/BL	LUMINARIA DE SOBREPONER EN MURO	EXTERIOR	ALUMINIO	BLANCO	10 w	100-240 V~	50-60 Hz	54	40,000 h	180°	576 lm	80	3,000 K



5720-LED/BL

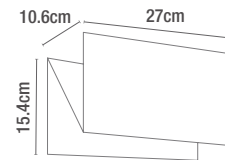

7820-LED/BL

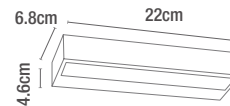

5720-LED/BL



CÓDIGO	DESCRIPCIÓN	USO	MATERIA PRIMA	TERMINADO	POTENCIA MÁX (W)	VOLTAJE	VAC-Hz	IP	VIDA PROMEDIO (h)	ÁNGULO DE APERTURA	LUMENS	IRC (CRI)	TEMPERATURA (K)
5720-LED/BL	LUMINARIA LED DE SOBREPONER EN MURO	EXTERIOR	ALUMINIO	BLANCO	15 W	100-130 V~	50-60 Hz	54	40,000 h	101 °	567 lm	83	3000 K
7820-LED/BL	LUMINARIA LED DE SOBREPONER EN MURO	EXTERIOR	ALUMINIO	BLANCO	16 W	100-240 V~	50-60 Hz	54	40,000 h	120°	1100 lm	80	3000 K

CL-8001-LED/BL

PRODUCTO
NUEVO

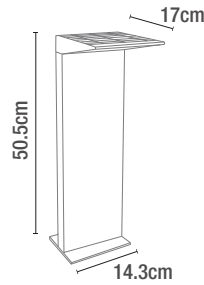

CL-8000-LED/BL

PRODUCTO
NUEVO

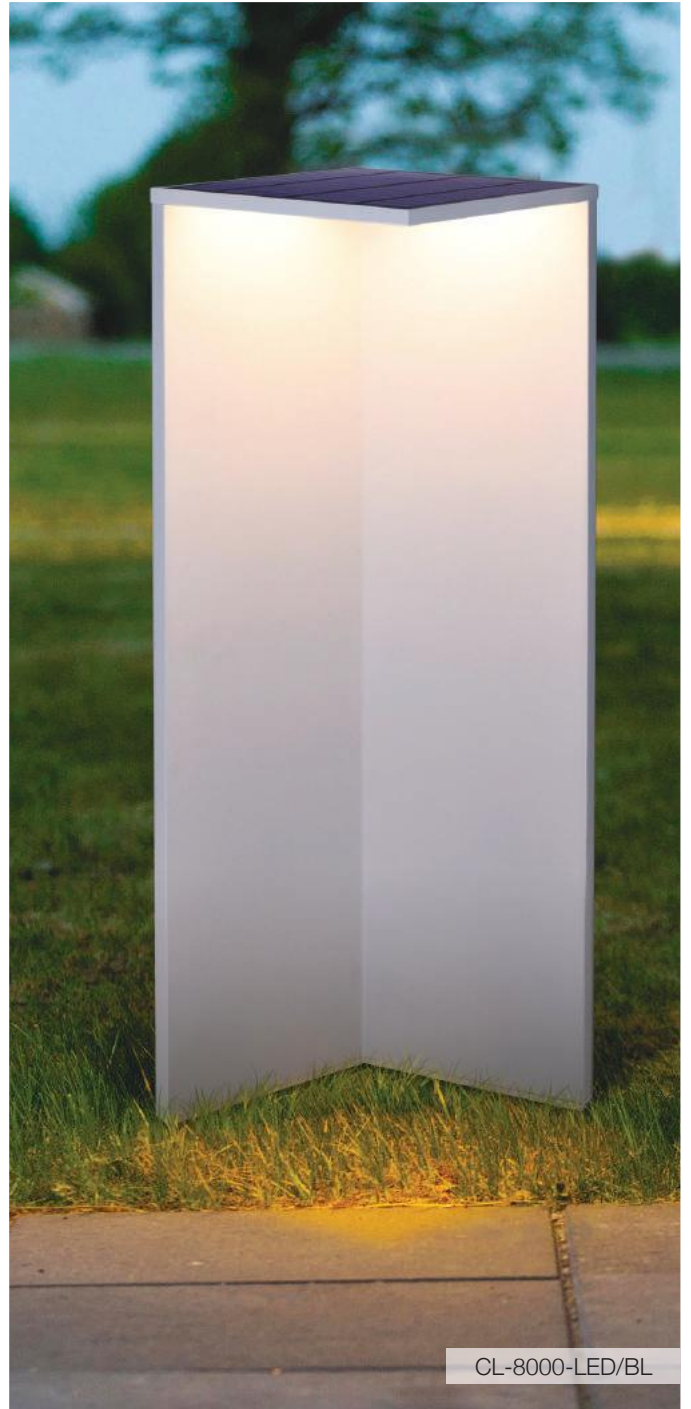

CL-8000-LED/BL



CÓDIGO	DESCRIPCIÓN	USO	MATERIA PRIMA	TERMINADO	POTENCIA MÁX (W)	VOLTAJE	IP	VIDA PROMEDIO (h)	ÁNGULO DE APERTURA	LUMENS	IRC (CRI)	TEMPERATURA (K)
CL-8001-LED/BL	LUMINARIA SOLAR CON SENSOR DE MOVIMIENTO PARA PISO	EXTERIOR	ALUMINIO	BLANCO	2.2 W	CELDA SOLAR	54	40,000 h	280°	INTENSIDAD AL 100%: 284 LM / INTENSIDAD AL 15%:42 LM	80	3000 K
CL-8000-LED/BL	LUMINARIA SOLAR CON SENSOR DE MOVIMIENTO PARA PISO	EXTERIOR	ALUMINIO	BLANCO	2.2 W	CELDA SOLAR	54	40,000 h	220°	INTENSIDAD AL 100%: 284 LM / INTENSIDAD AL 15%:42 LM	80	3000 K

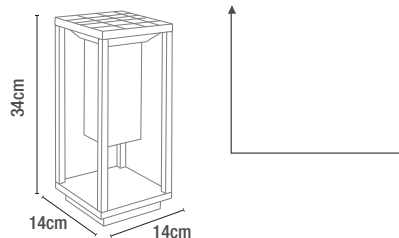
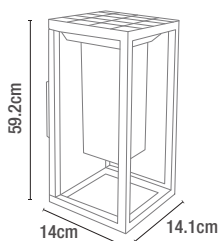
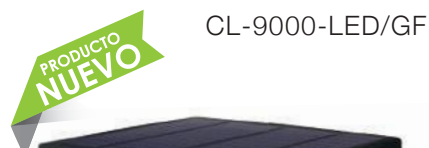

CL-9001-LED/GF

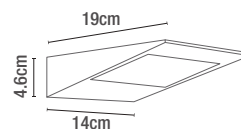

CÓDIGO	DESCRIPCIÓN	USO	MATERIA PRIMA	TERMINADO	POTENCIA MÁX (W)	VOLTAJE	IP	VIDA PROMEDIO (h)	ÁNGULO DE APERTURA	LUMENS	IRC (CRI)	TEMPERATURA (K)
CL-9000-LED/GF	LUMINARIA SOLAR CON SENSOR DE MOVIMIENTO DE SOBREPONER PARA MURO	EXTERIOR	ALUMINIO / PLÁSTICO	GRAFITO	2.2 W	CELDA SOLAR	54	40,000 h	180°	INTENSIDAD AL 100%: 280 LM / INTENSIDAD AL 15%: 30 lm	80	3000 K
CL-9001-LED/GF	LUMINARIA SOLAR CON SENSOR DE MOVIMIENTO DE SOBREPONER PARA MURO	EXTERIOR	ALUMINIO / PLÁSTICO	GRAFITO	2.2 W	CELDA SOLAR	54	40,000 h	180°	INTENSIDAD AL 100%: 284 LM / INTENSIDAD AL 15%: 42 lm	80	3000 K
CL-9002-LED/GF	LUMINARIA SOLAR CON SENSOR DE MOVIMIENTO PARA PISO CON ESTACA	EXTERIOR	ALUMINIO / PLÁSTICO	GRAFITO	2.2 W	CELDA SOLAR	54	40,000 h	360°	INTENSIDAD AL 100%: 280 LM / INTENSIDAD AL 15%: 30 lm	80	3000 K

CL-3614-LED/BL

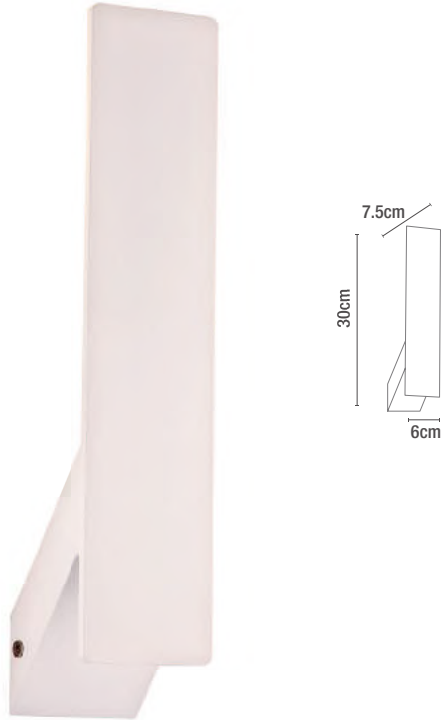

F2140-3W



7812-LED/BL

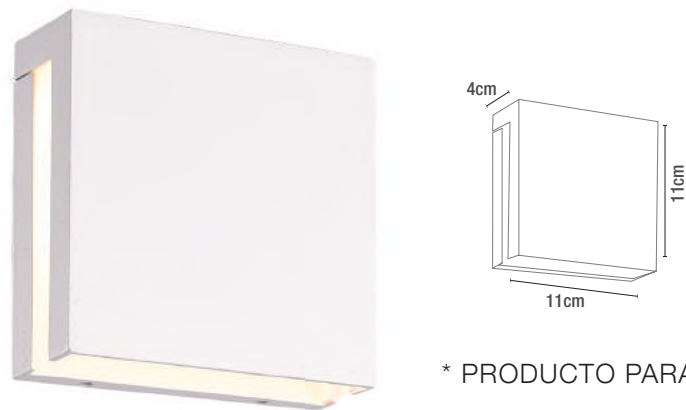

* PRODUCTO PARA EMPOTRAR



CÓDIGO	DESCRIPCIÓN	USO	MATERIA PRIMA	TERMINADO	POTENCIA MÁX (W)	VOLTAJE	VAC-Hz	IP	VIDA PROMEDIO (h)	ÁNGULO DE APERTURA	LUMENS	IRC (CRI)	TEMPERATURA (K)	CORTE DE EMPOTRAMIENTO
CL-3614-LED/BL	LUMINARIA LED DE SOBREPONER EN MURO	EXTERIOR	ALUMINIO	BLANCO	3 W	100-240 V~	50-60 Hz	44	40,000 h	120°	195 lm	82	3000 K	-
F2140-3W	LUMINARIA LED DIRIGIBLE CON APAGADOR DE SOBREPONER EN MURO	INTERIOR	ACERO	SATINADO	3 W	100-240 V~	50-60 Hz	20	40,000 h	30°	250 lm	80	3000 K	-
7812-LED/BL	LUMINARIA LED DE EMPOTRAR EN MURO	EXTERIOR	ALUMINIO	BLANCO	3.6 W	100-240 V~	50-60 Hz	65	40,000 h	56°	46 lm	80	3000 K	10 X 6.5 cm



CLARIDAD EN EL INTERIOR

Intensifica la nitidez de
tus memorias

F2130-3W

F2130-3W

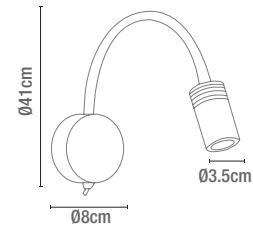

F1095-LED/SA

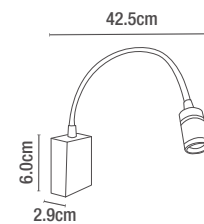

CÓDIGO	DESCRIPCIÓN	USO	MATERIA PRIMA	TERMINADO	POTENCIA MÁX (W)	VOLTAJE	VAC-Hz	VIDA PROMEDIO (h)	ÁNGULO DE APERTURA	LUMENS	IRC (CRI)	TEMPERATURA (K)
F2130-3W	LUMINARIA LED DIRIGIBLE CON APAGADOR DE SOBREPONER EN MURO	INTERIOR	ACERO	SATINADO	3 W	100-240 V~	50-60 Hz	40,000 h	30°	250 lm	80	3000 K
F1095-LED/SA	LUMINARIA LED DIRIGIBLE CON APAGADOR DE SOBREPONER EN MURO	INTERIOR	ALUMINIO	SATINADO	3 W	100-240 V~	50-60 Hz	40,000 h	45°	171 lm	80	3000 K

F1093-LED/CR

PRODUCTO
NUEVO

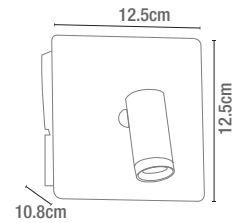

F1094-LED/CR

PRODUCTO
NUEVO

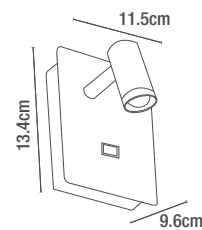

CÓDIGO	DESCRIPCIÓN	USO	MATERIA PRIMA	TERMINADO	POTENCIA MÁX (W)	VOLTAJE	VAC-Hz	VIDA PROMEDIO (h)	ÁNGULO DE APERTURA	LUMENS	IRC (CRI)	TEMPERATURA (K)
F1093-LED/CR	LUMINARIA LED CON LUZ DIRIGIBLE ADICIONAL Y APAGADOR PARA SOBREPONER EN MURO CON ENTRADA USB	INTERIOR	ALUMINIO	CROMO	6 W	100-240 V~	50-60 Hz	40,000 h	60° - 45°	319 lm	80	3 000 K
F1094-LED/CR	LUMINARIA LED DIRIGIBLE CON APAGADOR DE SOBREPONER EN MURO CON ENTRADA USB	INTERIOR	ALUMINIO	CROMO	3 W	100-240 V~	50-60 Hz	40,000 h	45°	171 lm	80	3 000 K

CL-1203-3-LED/CR

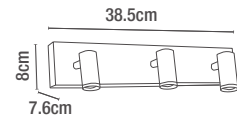

BLED10W

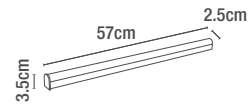

CL-1100-1-LED/SA

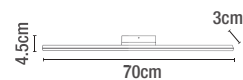

CÓDIGO	DESCRIPCIÓN	USO	MATERIA PRIMA	TERMINADO	POTENCIA MAX (W)	VOLTAJE	VAC-Hz	VIDA PROMEDIO (h)	ÁNGULO DE APERTURA	LUMENS	IRC (CRI)	TEMPERATURA (K)
CL-1203-3-LED/CR	LUMINARIA DE TRES LUCES LED DIRIGIBLES DE SOBREPONER EN MURO	INTERIOR	ALUMINIO	CROMO	15 W	100-240 V~	50-60 Hz	40,000 h	45°	1600 lm	80	3 000 K
BLED10W	BARRA LED DE SOBREPONER EN MURO Y TECHO	INTERIOR	ALUMINIO / POLICARBONATO	BLANCO	10 W	100-240 V~	50-60 Hz	40,000 h	135°	1000lm	80	3000 K
CL-1100-1-LED/SA	BARRA LED DE SOBREPONER EN MURO	INTERIOR	ALUMINIO	NIQUEL SATINADO	9 W	100-24 V~	50-60 Hz	40,000 h	120°	600 lm	80	3000 K

CL-1200-1-LED/CR

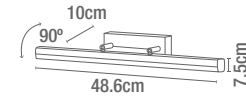

* PRODUCTO DIRIGIBLE

CL-1202-2-LED/CR

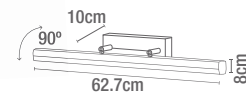

* PRODUCTO DIRIGIBLE

CL-1204-LED/SA

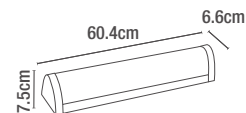

CÓDIGO	DESCRIPCIÓN	USO	MATERIA PRIMA	TERMINADO	POTENCIA MAX (W)	VOLTAJE	VAC-Hz	IP	VIDA PROMEDIO (h)	ÁNGULO DE APERTURA	LUMENS	IRC (CRI)	TEMPERATURA (K)
CL-1200-1-LED/CR	BARRA LED DIRIGIBLE DE SOBREPONER EN MURO	INTERIOR	ALUMINIO	CROMO	12 W	100-240 V~	50-60 Hz	44	40,000 h	110°	1060 lm	80	3 000 K
CL-1202-2-LED/CR	BARRA LED DIRIGIBLE DE SOBREPONER EN MURO	INTERIOR	ALUMINIO	CROMO	18 W	100-240 V~	50-60 Hz	44	40,000 h	110°	1600 lm	80	3 000 K
CL-1204-LED/SA	BARRA LED DE SOBREPONER EN MURO	INTERIOR	ALUMINIO / POLICARBONATO	SATIN	16 W	110-127 V~	50-60 Hz	44	40,000 h	165°	1200 lm	80	3 000 K

7720-LED

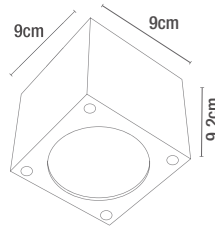

7920-LED

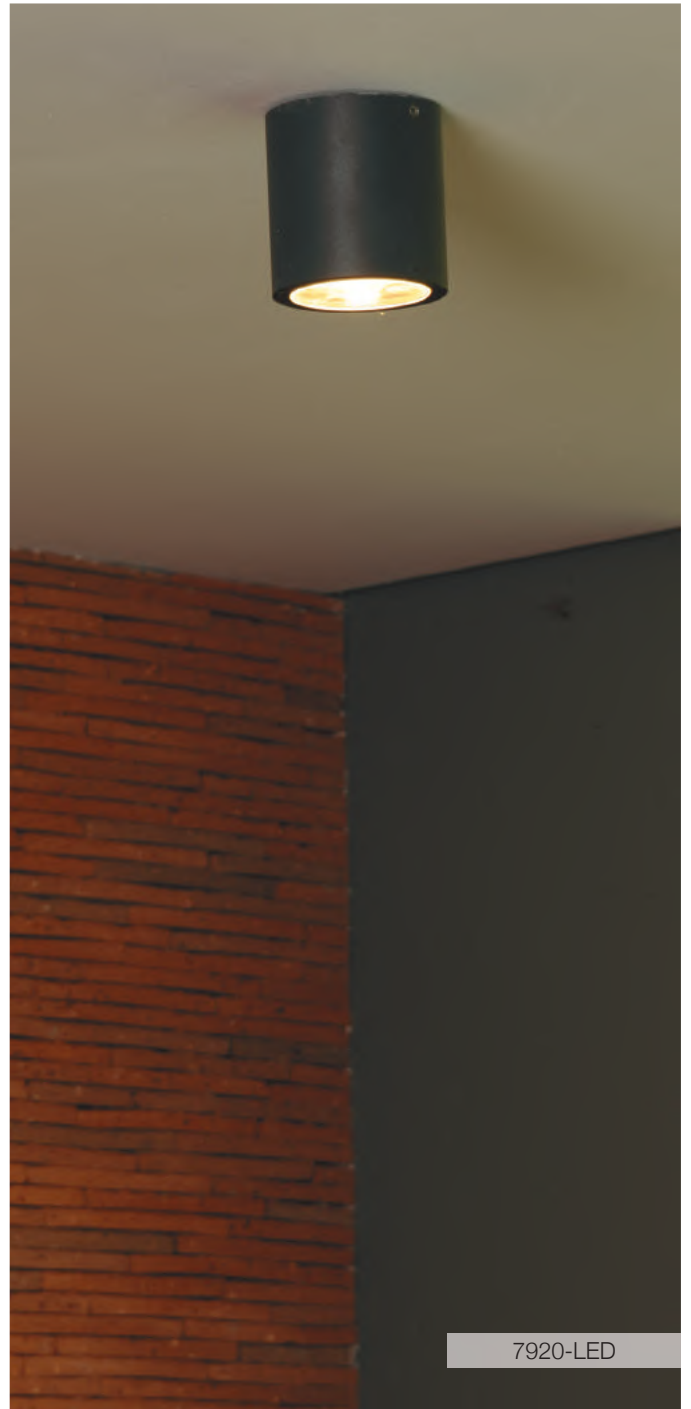
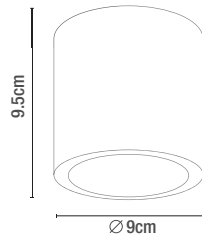

7920-LED



CÓDIGO	DESCRIPCIÓN	USO	MATERIA PRIMA	TERMINADO	POTENCIA MÁX (W)	VOLTAJE	VAC-Hz	IP	VIDA PROMEDIO (h)	ÁNGULO DE APERTURA	LUMENS	IRC (CRI)	TEMPERATURA (K)
7720-LED	LUMINARIA LED DE SOBREPONER EN TECHO	EXTERIOR	ALUMINIO	GRAFITO	7 W	100-240 V~	50-60 Hz	54	40,000 h	19°	581 lm	82	3000 K
7920-LED	LUMINARIA LED DE SOBREPONER EN TECHO	EXTERIOR	ALUMINIO	GRAFITO	7 W	100-240 V~	50-60 Hz	54	40,000 h	17°	575 lm	82	3000 K

PL300-12W

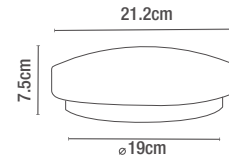

PL500-LED/CR

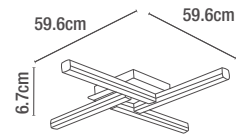

CÓDIGO	DESCRIPCIÓN	USO	MATERIA PRIMA	TERMINADO	POTENCIA MÁX (W)	VOLTAJE	VAC-Hz	VIDA PROMEDIO (h)	ÁNGULO DE APERTURA	LUMENS	IRC (CRI)	TEMPERATURA (K)
PL300-12W	LUMINARIA LED DE SOBREPONER EN TECHO	INTERIOR	ACERO / POLICARBONATO	BLANCO	12 W	100-240 V~	50-60 Hz	40,000 h	130°	900 lm	70	4100 K
PL500-LED/CR	LUMINARIA LED DE SOBREPONER EN TECHO	INTERIOR	ALUMINIO	CROMO	22 W	100-240 V~	50-60 Hz	40,000 h	110°	2440 lm	80	3 000 K

CL-3010-LED/BL

CL-1064-5-LED/BL

CA0236-2-LED/SA

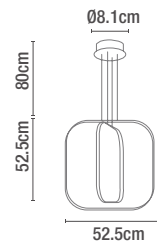
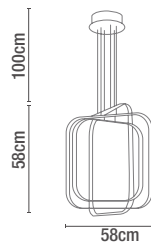
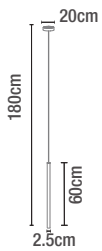

CÓDIGO	DESCRIPCIÓN	USO	MATERIA PRIMA	TERMINADO	POTENCIA MAX (W)	VOLTAJE	VAC-Hz	VIDA PROMEDIO (h)	ÁNGULO DE APERTURA	LUMENS	IRC (CRI)	TEMPERATURA (K)
CL-3010-LED/BL	LUMINARIA DE LED SUSPENDIDA PARA TECHO	INTERIOR	ALUMINIO	BLANCO	4 W	100-240 V~	50-60 Hz	40,000 h	20°	335 lm	80	3 000 K
CL-1064-5-LED/BL	LUMINARIA DE LED SUSPENDIDA PARA TECHO	INTERIOR	ALUMINIO	BLANCO	78 W	100-240 V~	50-60 Hz	40,000 h	360°	4400 lm	82	3000 K
CA0236-2-LED/SA	LUMINARIA DE LED SUSPENDIDA PARA TECHO	INTERIOR	ALUMINIO	SATINADO	50 W	100-240 V~	50-60 Hz	40,000 h	360°	2250 lm	82	3000 K

CL-0236-5-LED/SA

CL-3012-LED/NE

CL-5353-8-LED/SA

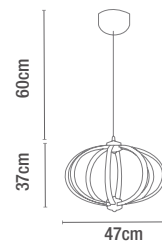
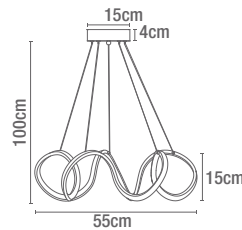
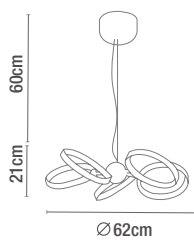

CÓDIGO	DESCRIPCIÓN	USO	MATERIA PRIMA	TERMINADO	POTENCIA MÁX (W)	VOLTAJE	VAC-Hz	VIDA PROMEDIO (h)	ÁNGULO DE APERTURA	LUMENS	IRC (CRI)	TEMPERATURA (K)
CL-0236-5-LED/SA	LUMINARIA DE LED SUSPENDIDA PARA TECHO	INTERIOR	ALUMINIO	SATINADO	35 W	100-240 V~	50-60 Hz	40,000 h	360°	1800 lm	82	3000 K
CL-3012-LED/NE	LUMINARIA DE LED SUSPENDIDA PARA TECHO	INTERIOR	ALUMINIO	NEGRO	48 W	100-240 V~	50-60 Hz	40,000 h	360°	2465 lm	80	3000 K
CL-5353-8-LED/SA	LUMINARIA DE LED SUSPENDIDA PARA TECHO	INTERIOR	ALUMINIO	SATINADO	45 W	100-240 V~	50-60 Hz	40,000 h	360°	2300 lm	82	3000 K

DL002-7W/C
DL002-7W/F

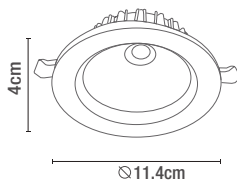

DL003-10W/N

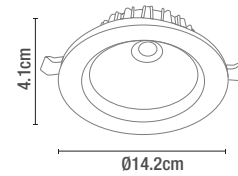

PRODUCTO
NUEVO

DL008-12W/F

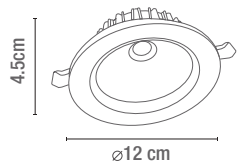

DL004-15W/N

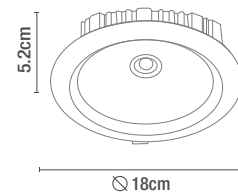

CÓDIGO	DESCRIPCIÓN	USO	MATERIA PRIMA	TERMINADO	POTENCIA MÁX (W)	VOLTAJE	VAC-Hz	VIDA PROMEDIO (h)	ÁNGULO DE APERTURA	LUMENS	IRC (CRI)	TEMPERATURA (K)	CORTE DE EMPOTRAMIENTO
DL002-7W/C DL002-7W/F	LUMINARIA LED PARA EMPOTRAR EN TECHO	INTERIOR	ALUMINIO / CRISTAL	BLANCO	7 W	100-240 V~	50-60 Hz	40,000 h	35°	525 lm	70	3000 K 6500 K	Ø 10 cm
DL003-10W/N	LUMINARIA LED PARA EMPOTRAR EN TECHO	INTERIOR	ALUMINIO / CRISTAL	BLANCO	10 W	100-240 V~	50-60 Hz	40,000 h	35°	750 lm	70	4100 K	Ø 10.2 cm
DL008-12W/F	LUMINARIA LED PARA EMPOTRAR EN TECHO	INTERIOR	ALUMINIO / CRISTAL	BLANCO	12 W	100-240 V~	50-60 Hz	40,000 h	35°	1125 lm	70	6500 K	Ø 15 cm
DL004-15W/N	LUMINARIA LED PARA EMPOTRAR EN TECHO	INTERIOR	ALUMINIO / CRISTAL	BLANCO	15 W	100-240 V~	50-60 Hz	40,000 h	35°	1125 lm	70	4100 K	Ø 15 cm

DL006-6.5W/C

PRODUCTO
NUEVO

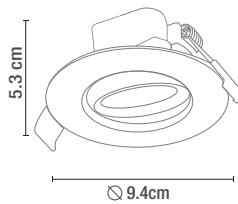

DL006-6.5W/N

PRODUCTO
NUEVO

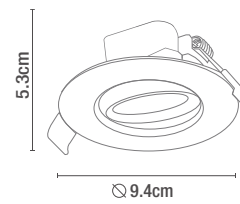

DL006-6.5W/F

PRODUCTO
NUEVO

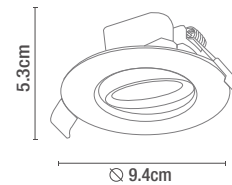

CÓDIGO	DESCRIPCIÓN	USO	MATERIA PRIMA	TERMINADO	POTENCIA MÁX (W)	VOLTAJE	VAC-Hz	IP	VIDA PROMEDIO (h)	ÁNGULO DE APERTURA	LUMENS	IRC (CRI)	TEMPERATURA (K)	CORTE DE EMPOTRAMIENTO
DL006-6.5W/C	LUMINARIA LED PARA EMPOTRAR EN TECHO	INTERIOR	PLASTICO	BLANCO	6.5 W	110-240 V~	50-60 Hz	20	40,000 h	38°	500 lm	80	3000 K	Ø6.8 cm
DL006-6.5W/N	LUMINARIA LED PARA EMPOTRAR EN TECHO	INTERIOR	PLASTICO	BLANCO	6.5 W	110-240 V~	50-60 Hz	20	40,000 h	38°	500 lm	80	4000 K	Ø6.8 cm
DL006-6.5W/F	LUMINARIA LED PARA EMPOTRAR EN TECHO	INTERIOR	PLASTICO	BLANCO	6.5 W	110-240 V~	50-60 Hz	20	40,000 h	38°	500 lm	80	6500 K	Ø6.8 cm

DLS009-3W/N

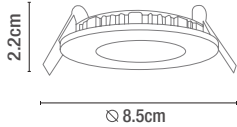

DLS010-6W/N

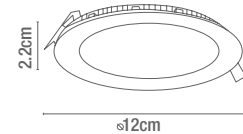

DLS011-9W/N

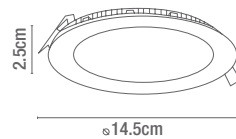

DLS012-12W/N

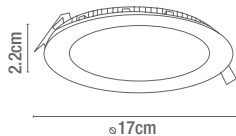

DLS014-18W/N

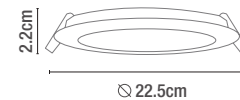

CÓDIGO	DESCRIPCIÓN	USO	MATERIA PRIMA	TERMINADO	POTENCIA MÁX (W)	VOLTAJE	VAC-Hz	IP	VIDA PROMEDIO (h)	ÁNGULO DE APERTURA	LUMENS	IRC (CRI)	TEMPERATURA (K)	CORTE DE EMPOTRAMIENTO
DLS009-3W/N	LUMINARIA LED PARA EMPOTRAR EN TECHO	INTERIOR	ALUMINIO / POLICARBONATO	BLANCO	3 W	100-240 V~	50-60 Hz	20	40,000 h	98°	200 lm	70	4100 K	Ø 6.3 cm
DLS010-6W/N	LUMINARIA LED PARA EMPOTRAR EN TECHO	INTERIOR	ALUMINIO / POLICARBONATO	BLANCO	6 W	100-240 V~	50-60 Hz	20	40,000 h	107°	390 lm	70	4100 K	10.5 Ø cm
DLS011-9W/N	LUMINARIA LED PARA EMPOTRAR EN TECHO	INTERIOR	ALUMINIO / POLICARBONATO	BLANCO	9 W	100-240 V~	50-60 Hz	20	40,000 h	107°	600 lm	70	4100 K	Ø 12.6 cm
DLS012-12W/N	LUMINARIA LED PARA EMPOTRAR EN TECHO	INTERIOR	ALUMINIO / POLICARBONATO	BLANCO	12 W	100-240 V~	50-60 Hz	20	40,000 h	107°	860 lm	70	4100 K	15.1 Ø cm
DLS014-18W/N	LUMINARIA LED PARA EMPOTRAR EN TECHO	INTERIOR	ALUMINIO / POLICARBONATO	BLANCO	18 W	100-240 V~	50-60 Hz	20	40,000 h	98°	1600 lm	70	4100 K	Ø 20 cm

DL007-12W/N

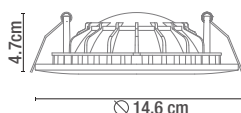

DL007-8W/N

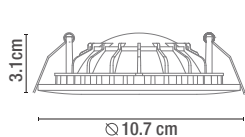

DL007-18W/N

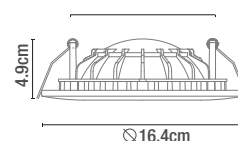

CÓDIGO	DESCRIPCIÓN	USO	MATERIA PRIMA	TERMINADO	POTENCIA MÁX (W)	VOLTAJE	VAC-Hz	IP	VIDA PROMEDIO (h)	ÁNGULO DE APERTURA	LUMENS	IRC (CRI)	TEMPERATURA (K)	CORTE DE EMPOTRAMIENTO
DL007-8W/N	LUMINARIA LED PARA EMPOTRAR EN TECHO	INTERIOR	ALUMINIO	BLANCO	8 W	100-240 V~	50-60 Hz	20	40,000 h	130°	330 lm	80	4 100 K	9.5 cm
DL007-12W/N	LUMINARIA LED PARA EMPOTRAR EN TECHO	INTERIOR	ALUMINIO	BLANCO	12 W	100-240 V~	50-60 Hz	20	40,000 h	130°	660 lm	80	4 100 K	13.5 cm
DL007-18W/N	LUMINARIA LED PARA EMPOTRAR EN TECHO	INTERIOR	ALUMINIO	BLANCO	18 W	100-240 V~	50-60 Hz	20	40,000 h	130°	900 lm	80	4 100 K	15 cm

DLP035-12W/N

PRODUCTO
NUEVO

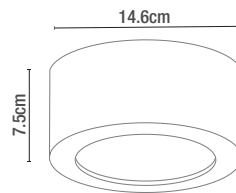

DLP032-12W

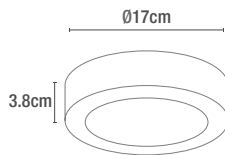

DLP036-18W

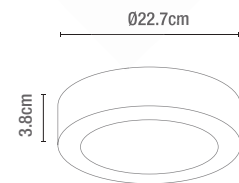

CÓDIGO	DESCRIPCIÓN	USO	MATERIA PRIMA	TERMINADO	POTENCIA MÁX (W)	VOLTAJE	VAC-Hz	IP	VIDA PROMEDIO (h)	ÁNGULO DE APERTURA	LUMENS	JRC (CRI)	TEMPERATURA (K)
DLP035-12W/N	LUMINARIA LED PARA SOBREPONER EN TECHO	INTERIOR	ALUMINIO	BLANCO	12 W	100-240 V~	50-60 Hz	20	40,000 h	130°	660 lm	80	4100 K
DLP032-12W	LUMINARIA LED PARA SOBREPONER EN TECHO	INTERIOR	ALUMINIO / POLICARBONATO	BLANCO	12 W	100-240 V~	50-60 Hz	20	40,000 h	110°	860 lm	70	4100 K
DLP036-18W	LUMINARIA LED DE SOBREPONER EN TECHO	INTERIOR	ALUMINIO / POLICARBONATO	BLANCO	18 W	100-240 V~	50-60 Hz	20	40,000 h	102°	1600 lm	70	4100 K

Q3043



REQUIERE DRIVER Q3029

Q3020



REQUIERE DRIVER Q3027

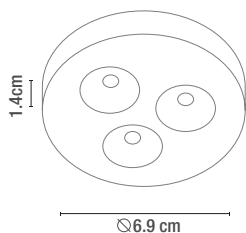

DRIVER Q3029

PARA 1-3PZS. LED DE 1W 350 MA

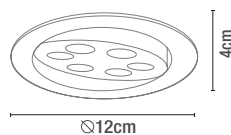

DRIVER Q3027

PARA 3-8PZS. LED DE 1W 350 MA

Q3025

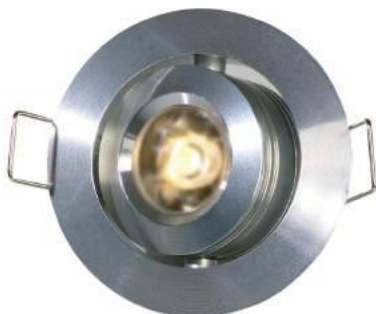

REQUIERE DRIVER Q3030

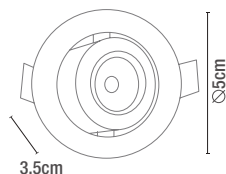

DRIVER Q3030

PARA 1-3PZS. LED DE 3W 700 MA

*NO INCLUYEN DRIVER



CÓDIGO	DESCRIPCIÓN	USO	MATERIA PRIMA	TERMINADO	POTENCIA MÁX (W)	VOLTAJE	VAC-Hz	VIDA PROMEDIO (h)	ÁNGULO DE APERTURA	LUMENS	IRC (CRI)	TEMPERATURA (K)	CORTE DE EMPOTRAMIENTO
Q3043	LUMINARIA LED DE SOBREPONER EN TECHO	INTERIOR	ALUMINIO	ALUMINIO MATE	3 W	100-240 V~	50-60 Hz	40,000 h	120°	240 lm	80	3000 K	N/A
Q3020	LUMINARIA LED PARA EMPOTRAR EN TECHO	INTERIOR	ALUMINIO	ALUMINIO MATE	6 W	100-240 V~	50-60 Hz	40,000 h	30°	480 lm	80	3000 K	9.7 cm
Q3025	LUMINARIA LED PARA EMPOTRAR EN TECHO	INTERIOR	ALUMINIO	ALUMINIO MATE	3 W	100-240 V~	50-60 Hz	40,000 h	30°	300 lm	80	3000 K	4.2 cm

MR16SMD5W/C

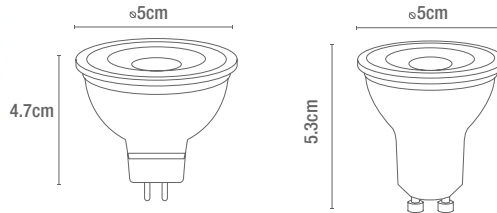

GU10SMD5W/F



FA199W-E27/C

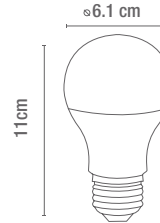

P45SMD4W/C

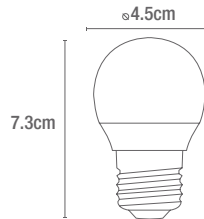

GX538W-E27/C

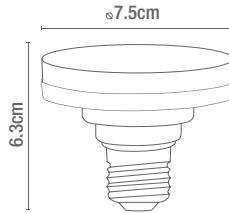

CÓDIGO	DESCRIPCIÓN	USO	MATERIA PRIMA	POTENCIA MAX (W)	VOLTAJE	VAC-HZ	IP	VIDA PROMEDIO (HR)	ÁNGULO DE APERTURA	LUMENS	IRC (CRI)	TEMPERATURA (K)	BASE
MR16SMD5W/C	LAMPARA DE LED	INTERIOR	ALUMINIO / PLASTICO	5 W	110 - 240 V~	50-60 Hz	20	15000 h	35°	350 lm	80	3000 °K 6500 °K	GX 5.3
MR16SMD5W/F	LAMPARA DE LED	INTERIOR	ALUMINIO / PLASTICO	5 W	110 - 240 V~	50-60 Hz	20	15000 h	35°	350 lm	80	3000 °K 6500 °K	GU10
FA199W-E27/C	LAMPARA DE LED	INTERIOR	ALUMINIO / PLASTICO	10 W	110 - 240 V~	50-60 Hz	20	15000 h	230°	800 lm	80	3000 °K 6500 °K	E-27
FA199W-E27/F	LAMPARA DE LED	INTERIOR	ALUMINIO / PLASTICO	10 W	110 - 240 V~	50-60 Hz	20	15000 h	230°	800 lm	80	3000 °K 6500 °K	E-27
P45SMD4W/C	LAMPARA DE LED	INTERIOR	ALUMINIO / PLASTICO	4.5W	110 - 240 V~	50-60 Hz	20	15000 h	260°	380 lm	80	3000 °K	E-27
GX538W-E27/C	LAMPARA DE LED	INTERIOR	ALUMINIO / PLASTICO	8 W	110 - 240 V~	50-60 Hz	20	15000 h	120 °	800 lm	80	3000 °K 6500 °K	E-27
GX538W-E27/F	LAMPARA DE LED	INTERIOR	ALUMINIO / PLASTICO	8 W	110 - 240 V~	50-60 Hz	20	15000 h	120 °	800 lm	80	3000 °K 6500 °K	E-27



LÍNEA EMPOTRADOS

Brinda claridad a los mejores recuerdos

CALUX
ILUMINA MEJOR

EM5080C-E27/B

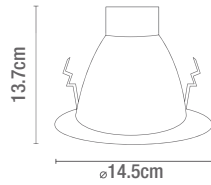
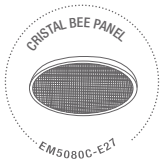

EM2010C-GU10/S

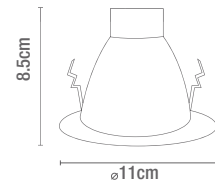

EM2020C-E27/B

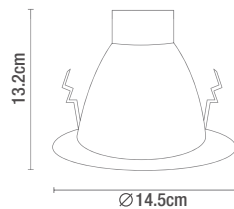

EM2020-E27/S

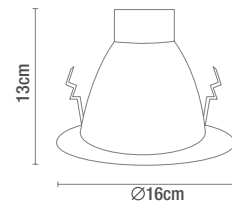

CÓDIGO	DESCRIPCIÓN	USO	MATERIA PRIMA	TERMINADO	POTENCIA MÁX (W)	VOLTAJE	VAC-Hz	IP	TIPO DE SOCKET	CORTE DE EMPOTRAMIENTO
EM5080C-E27/B	LUMINARIA PARA EMPOTRAR EN TECHO	INTERIOR	ACERO / CRISTAL	BLANCO	60 W	127 V~	50-60 Hz	20	E27	Ø 11.2 cm
EM5080C-E27/S	LUMINARIA PARA EMPOTRAR EN TECHO	INTERIOR	ACERO / CRISTAL	SATINADO	60 W	127 V~	50-60 Hz	20	E27	Ø 11.2 cm
EM2010C-GU10/S	LUMINARIA PARA EMPOTRAR EN TECHO	INTERIOR	ACERO / CRISTAL	BLANCO	50 W	127 V~	50-60 Hz	20	GU10	Ø 8.5 cm
EM2010C-GU10/B	LUMINARIA PARA EMPOTRAR EN TECHO	INTERIOR	ACERO / CRISTAL	SATINADO	50 W	127 V~	50-60 Hz	20	GU10	Ø 8.5 cm
EM2020-E27/S	LUMINARIA PARA EMPOTRAR EN TECHO	INTERIOR	ACERO	BLANCO	60 W	127 V~	50-60 Hz	20	E27	Ø 11.7 cm
EM2020C-E27/B	LUMINARIA PARA EMPOTRAR EN TECHO	INTERIOR	ACERO	SATINADO	60 W	127 V~	50-60 Hz	20	E27	Ø 11.7 cm
EM2020C-E27/B	LUMINARIA PARA EMPOTRAR EN TECHO	INTERIOR	ACERO / CRISTAL	BLANCO	60 W	127 V~	50-60 Hz	20	E27	Ø 11.7 cm
EM2020C-E27/S	LUMINARIA PARA EMPOTRAR EN TECHO	INTERIOR	ACERO / CRISTAL	SATINADO	60 W	127 V~	50-60 Hz	20	E27	Ø 11.7 cm



EM2015-E27/S

EM2015C-E27/B

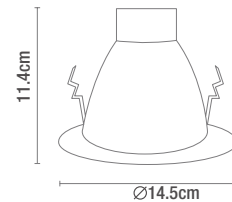
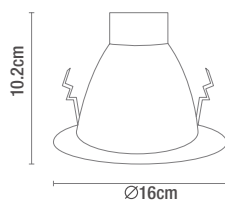

CÓDIGO	DESCRIPCIÓN	USO	MATERIA PRIMA	TERMINADO	POTENCIA MÁX (W)	VOLTAJE	VAC-Hz	IP	TIPO DE SOCKET	CORTE DE EMPOTRAMIENTO
EM2015-E27/S EM2015-E27/B	LUMINARIA PARA EMPOTRAR EN TECHO	INTERIOR	ACERO	SATINADO BLANCO	60 W	127 V~	50-60 Hz	20	E27	Ø 11.7 cm
EM2015C-E27/B EM2015C-E27/S	LUMINARIA PARA EMPOTRAR EN TECHO	INTERIOR	ACERO / CRISTAL	BLANCO SATINADO	60 W	127 V~	50-60 Hz	20	E27	Ø 11.7 cm

H2010/S

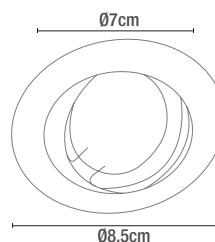

H5010/S

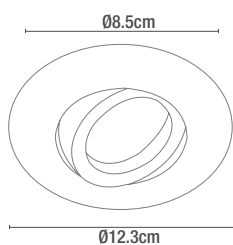

H4010/B

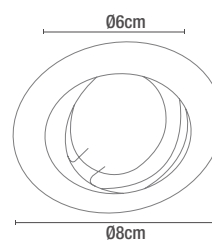

CÓDIGO	DESCRIPCIÓN	USO	MATERIA PRIMA	TERMINADO	POTENCIA MÁX (W)	VOLTAJE	VAC-Hz	IP	TIPO DE SOCKET	CORTE DE EMPOTRAMIENTO
H2010/S	LUMINARIA DIRIGIBLE PARA EMPOTRAR EN TECHO	INTERIOR	ALUMINIO	BLANCO	50 W	127 V~	50-60 Hz	20	GX5.3	7 cm
H2010/B	LUMINARIA DIRIGIBLE PARA EMPOTRAR EN TECHO	INTERIOR	ALUMINIO	SATINADO	50 W	127 V~	50-60 Hz	20	GX5.3	7 cm
H5010/S	LUMINARIA DIRIGIBLE PARA EMPOTRAR EN TECHO	INTERIOR	ALUMINIO	BLANCO	50 W	127 V~	50-60 Hz	20	GX5.3	8.5 cm
H5010/B	LUMINARIA DIRIGIBLE PARA EMPOTRAR EN TECHO	INTERIOR	ALUMINIO	SATINADO	50 W	127 V~	50-60 Hz	20	GX5.3	8.5 cm
H4010/B	LUMINARIA PARA EMPOTRAR EN TECHO	INTERIOR	ACERO	BLANCO	50 W	127 V~	50-60 Hz	20	GX5.3	6 cm
H4010/S	LUMINARIA PARA EMPOTRAR EN TECHO	INTERIOR	ACERO	SATINADO	50 W	127 V~	50-60 Hz	20	GX5.3	6 cm

7615-GU10/BL

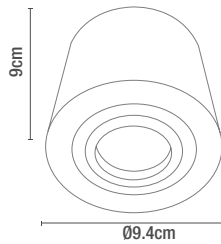

7610-GU10/BL

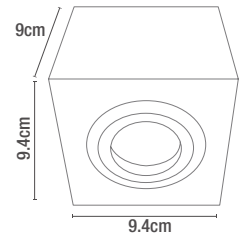

H5001/BL

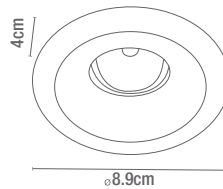

H5002/BL

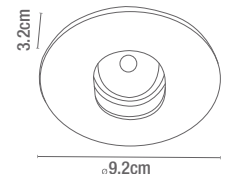

CÓDIGO	DESCRIPCIÓN	USO	MATERIA PRIMA	TERMINADO	POTENCIA MÁX (W)	VOLTAJE	VAC-Hz	IP	TIPO DE SOCKET	CORTE DE EMPOTRAMIENTO
7615-GU10/BL	LUMINARIA DIRIGIBLE DE SOBREPONER EN TECHO	INTERIOR	ALUMINIO	BLANCO	50 W	127 V~	50-60 Hz	20	GU10	N/A
7610-GU10/BL	LUMINARIA DIRIGIBLE DE SOBREPONER EN TECHO	INTERIOR	ALUMINIO	BLANCO	50 W	127 V~	50-60 Hz	20	GU10	N/A
H5001/BL	LUMINARIA PARA EMPOTRAR EN TECHO	INTERIOR	ALUMINIO	BLANCO	50 W	127 V~	50-60 Hz	20	GU10	Ø 8.0
H5002/BL	LUMINARIA PARA EMPOTRAR EN TECHO	INTERIOR	ALUMINIO	BLANCO	50 W	127 V~	50-60 Hz	20	GU10	Ø 7.4

AMBIENTACIÓN ÚNICA

Crea el estilo que vaya
con tu personalidad



LY2018-GU10

LY2010-GU10

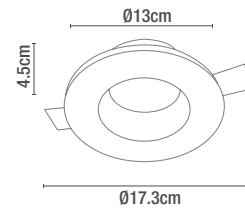

LY2018-GU10

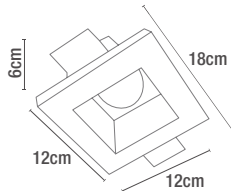

LY2019-GU10

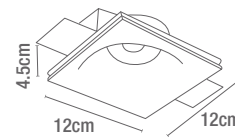

CÓDIGO	DESCRIPCIÓN	USO	MATERIA PRIMA	TERMINADO	POTENCIA MÁX (W)	VOLTAJE	VAC-Hz	IP	TIPO DE SOCKET	CORTE DE EMPOTRAMIENTO
LY2010-GU10	LUMINARIA DE YESO PARA EMPOTRAR EN TECHO	INTERIOR	YESO	BLANCO	35 W	127 V~	50-60 Hz	20	GU10	13 cm
LY2018-GU10	LUMINARIA DE YESO PARA EMPOTRAR EN TECHO	INTERIOR	YESO	BLANCO	35 W	127 V~	50-60 Hz	20	GU10	12 cm
LY2019-GU10	LUMINARIA DE YESO PARA EMPOTRAR EN TECHO	INTERIOR	YESO	BLANCO	35 W	127 V~	50-60 Hz	20	GU10	12 cm



A photograph of a modern entrance featuring a wooden door with a glass insert, a stainless steel handrail, and a wall-mounted light fixture. The scene is set against a textured wall with a potted plant in the foreground.

LÍNEA ALUMINIO

Muestra calidez en el exterior

CALUX
ILUMINA MEJOR

5001/B

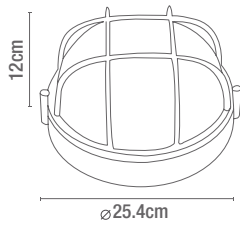

5011/N

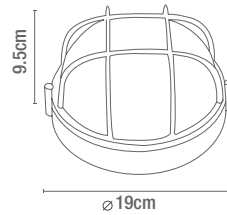

5031/B

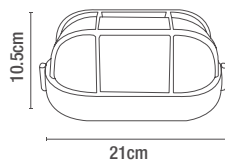

5021/N

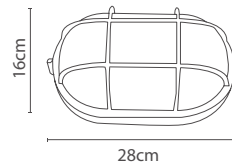

CÓDIGO	DESCRIPCIÓN	USO	MATERIA PRIMA	TERMINADO	POTENCIA MÁX (W)	VOLTAJE	VAC-Hz	IP	TIPO DE SOCKET	# DE SOCKET
5001/B	LUMINARIA DE SOBREPONER EN MURO O TECHO	EXTERIOR	ALUMINIO / CRISTAL	BLANCO	60 W	127 V~	50-60 Hz	44	E27	1
5011/N	LUMINARIA DE SOBREPONER EN MURO O TECHO	EXTERIOR	ALUMINIO / CRISTAL	NEGRO BLANCO	60 W	127 V~	50-60 Hz	44	E27	1
5031/N	LUMINARIA DE SOBREPONER EN MURO O TECHO	EXTERIOR	ALUMINIO / CRISTAL	NEGRO BLANCO	60 W	127 V~	50-60 Hz	44	E27	1
5021/N	LUMINARIA DE SOBREPONER EN MURO O TECHO	EXTERIOR	ALUMINIO / CRISTAL	NEGRO BLANCO	60 W	127 V~	50-60 Hz	44	E27	1

5462/GF

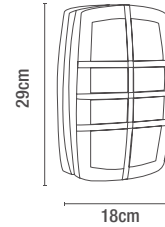

5463

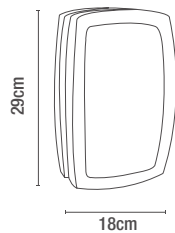

5466/GF

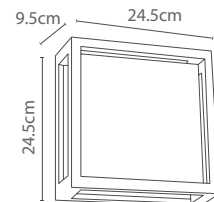

CÓDIGO	DESCRIPCIÓN	USO	MATERIA PRIMA	TERMINADO	POTENCIA MÁX (W)	VOLTAJE	VAC-Hz	IP	TIPO DE SOCKET	# DE SOCKET
5462/GF	LUMINARIA DE SOBREPONER EN MURO O TECHO	EXTERIOR	ALUMINIO / POLICARBONATO	GRAFITO	80 W	127 V~	50-60 Hz	54	E27	2
5463	LUMINARIA DE SOBREPONER EN MURO O TECHO	EXTERIOR	ALUMINIO / POLICARBONATO	GRAFITO	80 W	127 V~	50-60 Hz	54	E27	2
5466/GF	LUMINARIA DE SOBREPONER EN MURO O TECHO	EXTERIOR	ALUMINIO / CRISTAL	GRAFITO	80 W	127 V~	50-60 Hz	54	E27	2

5491/GF

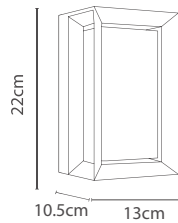

5468/GF

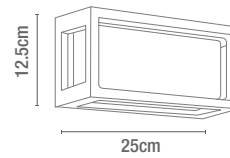

5192/N

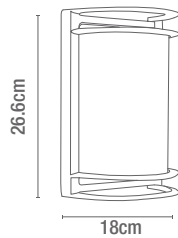

5194/N

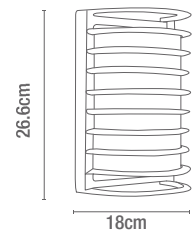

CÓDIGO	DESCRIPCIÓN	USO	MATERIA PRIMA	TERMINADO	POTENCIA MAX (W)	VOLTAJE	VAC-Hz	IP	TIPO DE SOCKET	# DE SOCKET
5491/GF	LUMINARIA DE SOBREPONER EN MURO	EXTERIOR	ALUMINIO / POLICARBONATO	GRAFITO	60 W	127 V~	50-60 Hz	54	E27	1
5468/GF	LUMINARIA DE SOBREPONER EN MURO	EXTERIOR	ALUMINIO / CRISTAL	GRAFITO	60 W	127 V~	50-60 Hz	54	E27	1
5192/N	LUMINARIA DE SOBREPONER EN MURO	EXTERIOR	ALUMINIO / CRISTAL	NEGRO GRIS	60 W	127 V~	50-60 Hz	44	E27	1
5194/N	LUMINARIA DE SOBREPONER EN MURO	EXTERIOR	ALUMINIO / CRISTAL	NEGRO GRIS	60 W	127 V~	50-60 Hz	44	E27	1

2012-E27/GF

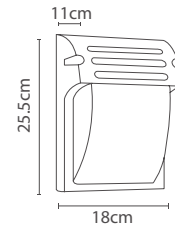

2008-E27/GF

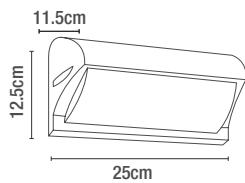

2009-E27/GF

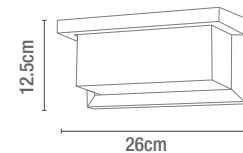

CÓDIGO	DESCRIPCIÓN	USO	MATERIA PRIMA	TERMINADO	POTENCIA MAX (W)	VOLTAJE	VAC-Hz	IP	TIPO DE SOCKET	# DE SOCKET
2012-E27/GF	LUMINARIA DE SOBREPONER EN MURO	EXTERIOR	ALUMINIO / POLICARBONATO	GRAFITO	60 W	127 V~	50-60 Hz	54	E27	1
2008-E27/GF	LUMINARIA DE SOBREPONER EN MURO	EXTERIOR	ALUMINIO / POLICARBONATO	GRAFITO	60 W	127 V~	50-60 Hz	54	E27	1
2009-E27/GF	LUMINARIA DE SOBREPONER EN MURO	EXTERIOR	ALUMINIO / POLICARBONATO	GRAFITO	60 W	127 V~	50-60 Hz	54	E27	1

5461/GF

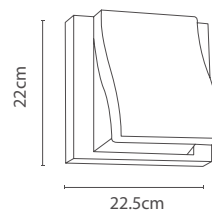
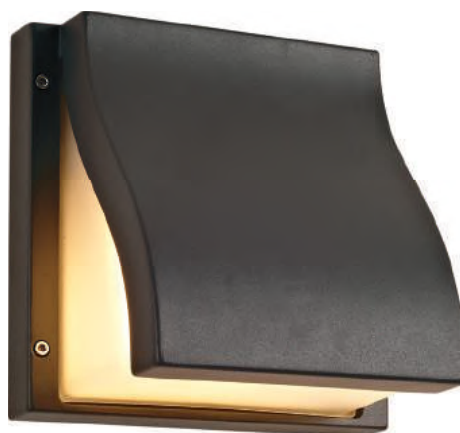

5464/GF

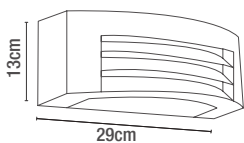

5471

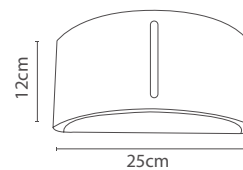

CÓDIGO	DESCRIPCIÓN	USO	MATERIA PRIMA	TERMINADO	POTENCIA MÁX (W)	VOLTAJE	VAC-Hz	IP	TIPO DE SOCKET	# DE SOCKET
5461/GF	LUMINARIA DE SOBREPONER EN MURO	EXTERIOR	ALUMINIO / ACRILICO	GRAFITO	80 W	127 V~	50-60 Hz	54	E27	2
5464/GF	LUMINARIA DE SOBREPONER EN MURO	EXTERIOR	ALUMINIO / POLICARBONATO	GRAFITO	60 W	127 V~	50-60 Hz	54	E27	1
5471	LUMINARIA DE SOBREPONER EN MURO	EXTERIOR	ALUMINIO / POLICARBONATO	GRAFITO	60 W	127 V~	50-60 Hz	54	E27	1

ENERGÍA POSITIVA EN TU JARDÍN

Elimina cualquier
resquicio de
oscuridad



5482/BL



PRODUCTO NUEVO

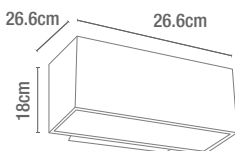

5481/BL



PRODUCTO NUEVO

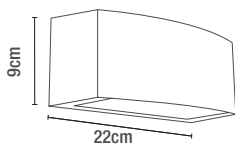

5481

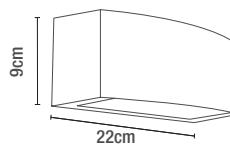

CÓDIGO	DESCRIPCIÓN	USO	MATERIA PRIMA	TERMINADO	POTENCIA MÁX (W)	VOLTAJE	VAC-Hz	IP	TIPO DE SOCKET	# DE SOCKET
5482/GF 5482/BL	LUMINARIA DE SOBREPONER EN MURO	EXTERIOR	ALUMINIO / CRISTAL	GRAFITO BLANCO	60 W	127 V~	50-60 Hz	54	E27	1
5481/BL	LUMINARIA DE SOBREPONER EN MURO	EXTERIOR	ALUMINIO / CRISTAL	BLANCO	60 W	127 V~	50-60 Hz	54	E27	1
5481	LUMINARIA DE SOBREPONER EN MURO	EXTERIOR	ALUMINIO / CRISTAL	GRAFITO	60 W	127 V~	50-60 Hz	54	E27	1

9283-GU10/GF



9271-GU10/BL



9282-GU10/GF



7635-GU10/GF



CÓDIGO	DESCRIPCIÓN	USO	MATERIA PRIMA	TERMINADO	POTENCIA MÁX (W)	VOLTAJE	VAC-Hz	IP	TIPO DE SOCKET	# DE SOCKET
9283-GU10/GF	LUMINARIA DE SOBREPONER EN MURO	EXTERIOR	ALUMINIO / CRISTAL	GRAFITO BLANCO	35 W	127 V~	50-60 Hz	54	GU10	1
9271-GU10/BL	LUMINARIA DE SOBREPONER EN MURO	EXTERIOR	ALUMINIO / CRISTAL	BLANCO GRAFITO	70 W	127 V~	50-60 Hz	54	GU10	2
9282-GU10/GF	LUMINARIA DE SOBREPONER EN MURO	EXTERIOR	ALUMINIO / CRISTAL	GRAFITO	35 W	127 V~	50-60 Hz	54	GU10	1
7635-GU10/GF	LUMINARIA DE SOBREPONER EN TECHO	EXTERIOR	ALUMINIO / CRISTAL	GRAFITO	35 W	127 V~	50-60 Hz	54	GU10	1

9268-GU10/GF

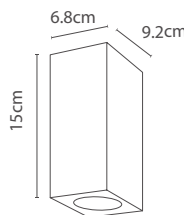

9281-GU10/BL

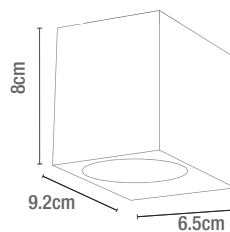

9268-GU10/GF



CÓDIGO	DESCRIPCIÓN	USO	MATERIA PRIMA	TERMINADO	POTENCIA MÁX (W)	VOLTAJE	VAC-Hz	IP	TIPO DE SOCKET	# DE SOCKET
9268-GU10/GF	LUMINARIA DE SOBREPONER EN MURO	EXTERIOR	ALUMINIO / CRISTAL	GRAFITO BLANCO	70 W	127 V~	50-60 Hz	44	GU10	2
9281-GU10/BL	LUMINARIA DE SOBREPONER EN MURO	EXTERIOR	ALUMINIO / CRISTAL	BLANCO GRAFITO	35 W	127 V~	50-60 Hz	44	GU10	1

9274-GU10/BL

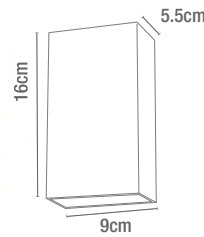

9270-GU10/BL

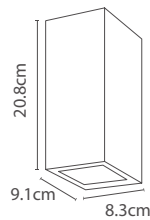

9272-GU10/GF

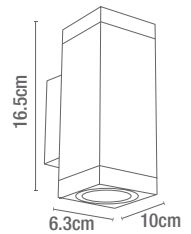

CÓDIGO	DESCRIPCIÓN	USO	MATERIA PRIMA	TERMINADO	POTENCIA MÁX (W)	VOLTAJE	VAC-Hz	IP	TIPO DE SOCKET	# DE SOCKET
9274-GU10/BL 9274-GU10/GF	LUMINARIA DE SOBREPONER EN MURO	EXTERIOR	ALUMINIO / CRISTAL	BLANCO GRAFITO	70 W	127 V~	50-60 Hz	54	GU10	2
9270-GU10/GF 9270-GU10/BL	LUMINARIA DE SOBREPONER EN MURO	EXTERIOR	ALUMINIO / CRISTAL	GRAFITO BLANCO	70 W	127 V~	50-60 Hz	54	GU10	2
9272-GU10/GF	LUMINARIA DE SOBREPONER EN MURO	EXTERIOR	ALUMINIO / CRISTAL	GRAFITO	70 W	127 V~	50-60 Hz	54	GU10	2



2013-GU10/GF

2013-GU10/GF

2011-GU10/GF

PRODUCTO
NUEVO

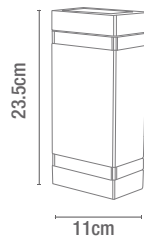

PRODUCTO
NUEVO

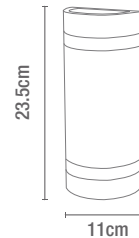

CÓDIGO	DESCRIPCIÓN	USO	MATERIA PRIMA	TERMINADO	POTENCIA MÁX (W)	VOLTAJE	VAC-Hz	IP	TIPO DE SOCKET	# DE SOCKET
2013-GU10/GF	LUMINARIA DE SOBREPONER EN MURO	EXTERIOR	ALUMINIO / POLICARBONATO	GRAFITO	70 W	100-240 V~	50-60 Hz	54	GU10	2
2011-GU10/GF	LUMINARIA DE SOBREPONER EN MURO	EXTERIOR	ALUMINIO / POLICARBONATO	GRAFITO	70 W	100-240 V~	50-60 Hz	54	GU10	2

8372/GF

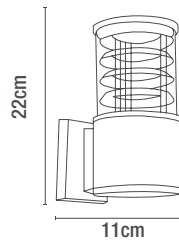

8372/GF

8362

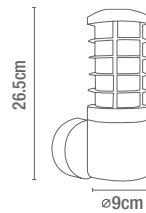

CÓDIGO	DESCRIPCIÓN	USO	MATERIA PRIMA	TERMINADO	POTENCIA MÁX (W)	VOLTAJE	VAC-Hz	IP	TIPO DE SOCKET	# DE SOCKET
8372/GF	LUMINARIA DE SOBREPONER EN MURO	EXTERIOR	ALUMINIO / CRISTAL	GRAFITO	60 W	127 V~	50-60 Hz	54	E27	1
8362	LUMINARIA DE SOBREPONER EN MURO	EXTERIOR	ALUMINIO / CRISTAL	GRAFITO	60 W	127 V~	50-60 Hz	54	E27	1

8382

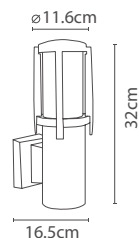

9273-GU10/GF

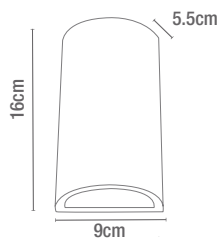

9269-GU10-BL

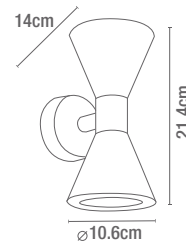

CÓDIGO	DESCRIPCIÓN	USO	MATERIA PRIMA	TERMINADO	POTENCIA MÁX (W)	VOLTAJE	VAC-Hz	IP	TIPO DE SOCKET	# DE SOCKET
8382	LUMINARIA DE SOBREPONER EN MURO	EXTERIOR	ALUMINIO / CRISTAL	GRAFITO	60 W	127V~	50-60 Hz	54	E27	1
9273-GU10/GF 9273-GU10/BL	LUMINARIA DE SOBREPONER EN MURO	EXTERIOR	ALUMINIO / CRISTAL	GRAFITO BLANCO	70 W	127 V~	50-60 Hz	54	GU10	2
9269-GU10/BL	LUMINARIA DE SOBREPONER EN MURO	EXTERIOR	ALUMINIO / CRISTAL	BLANCO	70 W	127 V~	50-60 Hz	65	GU10	2

8373S-E27/GF

PRODUCTO
NUEVO

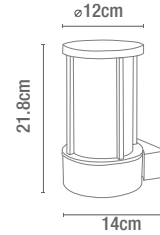

8374S-E27/GF

PRODUCTO
NUEVO

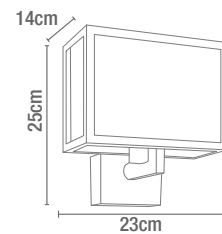

CÓDIGO	DESCRIPCIÓN	USO	MATERIA PRIMA	TERMINADO	POTENCIA MÁX (W)	VOLTAJE	VAC-Hz	IP	TIPO DE SOCKET	# DE SOCKET
8373S-E27/GF	LUMINARIA DE SOBREPONER PARA MURO CON SENSOR DE MOVIMIENTO	EXTERIOR	ALUMINIO / CRISTAL	GRAFITO	60 W	127 V~	50-60 Hz	54	E27	1
8374S-E27/GF	LUMINARIA DE SOBREPONER PARA MURO CON SENSOR DE MOVIMIENTO	EXTERIOR	ALUMINIO / CRISTAL	GRAFITO	60 W	127 V~	50-60 Hz	54	E27	1

4542

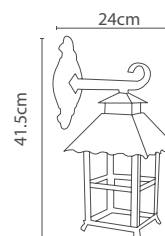

6502

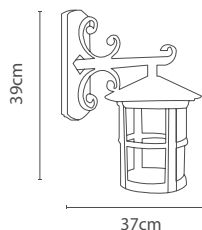

6512

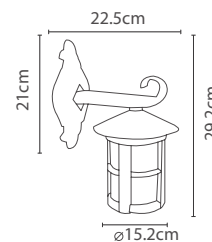

CÓDIGO	DESCRIPCIÓN	USO	MATERIA PRIMA	TERMINADO	POTENCIA MÁX (W)	VOLTAJE	VAC-Hz	IP	TIPO DE SOCKET	# DE SOCKET
4542	LUMINARIA DE SOBREPONER EN MURO	EXTERIOR	ALUMINIO / CRISTAL	RUSTICO	60 W	127 V~	50-60 Hz	54	E27	1
6502	LUMINARIA DE SOBREPONER EN MURO	EXTERIOR	ALUMINIO / CRISTAL	RUSTICO	60 W	127 V~	50-60 Hz	54	E27	1
6512	LUMINARIA DE SOBREPONER EN MURO	EXTERIOR	ALUMINIO / CRISTAL	RUSTICO	60 W	127 V~	50-60 Hz	54	E27	1

6501

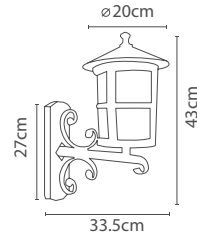

6041/N

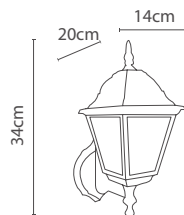

7040

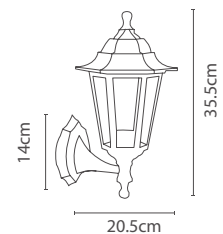

NOTA: HECHO DE POLIPROPILENO



CÓDIGO	DESCRIPCIÓN	USO	MATERIA PRIMA	TERMINADO	POTENCIA MÁX (W)	VOLTAJE	VAC-Hz	IP	TIPO DE SOCKET	# DE SOCKET
6501	LUMINARIA DE SOBREPONER EN MURO	EXTERIOR	ALUMINIO / CRISTAL	RUSTICO	60 W	127 V~	50-60 Hz	54	E27	1
6041/N 6041/O	LUMINARIA DE SOBREPONER EN MURO	EXTERIOR	ALUMINIO / CRISTAL	NEGRO OXIDO	60 W	127 V~	50-60 Hz	54	E27	1
7040	LUMINARIA DE SOBREPONER EN MURO	EXTERIOR	POLIPROPILENO / CRISTAL	NEGRO	60 W	127 V~	50-60 Hz	54	E27	1

4544

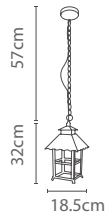

6504

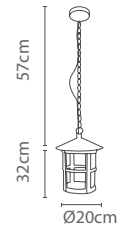

6042/GF

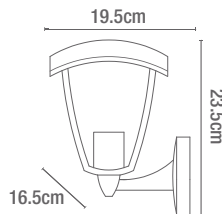

6043/GF

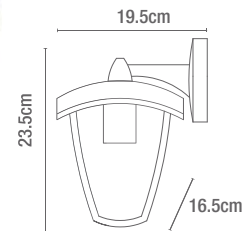

CÓDIGO	DESCRIPCIÓN	USO	MATERIA PRIMA	TERMINADO	POTENCIA MÁX (W)	VOLTAJE	VAC-Hz	IP	TIPO DE SOCKET	# DE SOCKET
4544	LUMINARIA SUSPENDIDA PARA TECHO	EXTERIOR	ALUMINIO / CRISTAL	RUSTICO	60 W	125 V~	50-60 Hz	54	E27	1
6504	LUMINARIA SUSPENDIDA PARA TECHO	EXTERIOR	ALUMINIO / CRISTAL	RUSTICO	60 W	125 V~	50-60 Hz	54	E27	1
6042/GF 6042/O 6042/NE	LUMINARIA DE SOBREPONER EN MURO	EXTERIOR	ALUMINIO / ACRILICO	GRAFITO OXIDO NEGRO	40 W	127 V~	50-60 Hz	44	E27	1
6043/GF 6043/O 6043/NE	LUMINARIA DE SOBREPONER EN MURO	EXTERIOR	ALUMINIO / ACRILICO	GRAFITO OXIDO NEGRO	40 W	127 V~	50-60 Hz	44	E27	1

6300



8373S-500/GF



CÓDIGO	DESCRIPCIÓN	USO	MATERIA PRIMA	TERMINADO	POTENCIA MAX (W)	VOLTAJE	VAC-Hz	IP	TIPO DE SOCKET	# DE SOCKET
6300	LUMINARIA PARA JARDIN CON ESTACA	EXTERIOR	ALUMINIO / CRISTAL	NEGRO	35 W	127 V~	50-60 Hz	54	GU10	1
8373S-500/GF	MINIPOSTE CON SENSOR DE MOVIMIENTO	EXTERIOR	ALUMINIO / CRISTAL	GRAFITO	60 W	127 V~	50-60 Hz	54	E27	1

RAYOS QUE DESLUMBRAN

Haz de lo cotidiano
algo espectacular

8363-650



8383-650

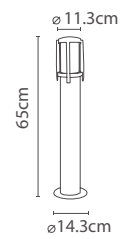

CÓDIGO	DESCRIPCIÓN	USO	MATERIA PRIMA	TERMINADO	POTENCIA MÁX (W)	VOLTAJE	VAC-Hz	IP	TIPO DE SOCKET	# DE SOCKET
8363-650	MINIPOSTE	EXTERIOR	ALUMINIO	GRAFITO	20 W	100-240 V~	50-60 Hz	54	E27	1
8383-650	MINIPOSTE	EXTERIOR	ALUMINIO	GRAFITO	20 W	100-240 V~	50-60 Hz	54	E27	1



LÍNEA INOX

Comparte las estrellas con los tuyos

CALUX
ILUMINA MEJOR

8143

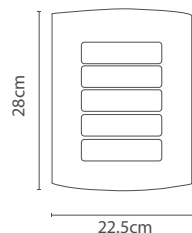

8144

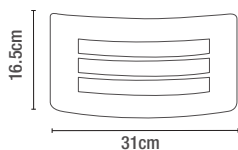

8145

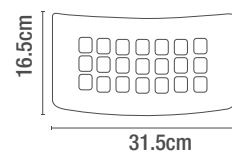

CÓDIGO	DESCRIPCIÓN	USO	MATERIA PRIMA	TERMINADO	POTENCIA MÁX (W)	VOLTAJE	VAC-Hz	IP	TIPO DE SOCKET	# DE SOCKET
8143	LUMINARIA DE SOBREPONER PARA MURO	EXTERIOR	ACERO INOX / POLICARBONATO	INOXIDABLE	60 W	127 V~	50-60 Hz	44	E27	1
8144	LUMINARIA DE SOBREPONER PARA MURO	EXTERIOR	ACERO INOX / POLICARBONATO	INOXIDABLE	40 W	127 V~	50-60 Hz	54	E27	1
8145	LUMINARIA DE SOBREPONER PARA MURO	EXTERIOR	ACERO INOX / POLICARBONATO	INOXIDABLE	40 W	127 V~	50-60 Hz	54	E27	1

8146

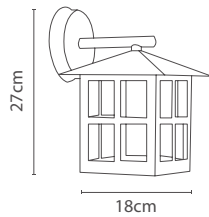

8148

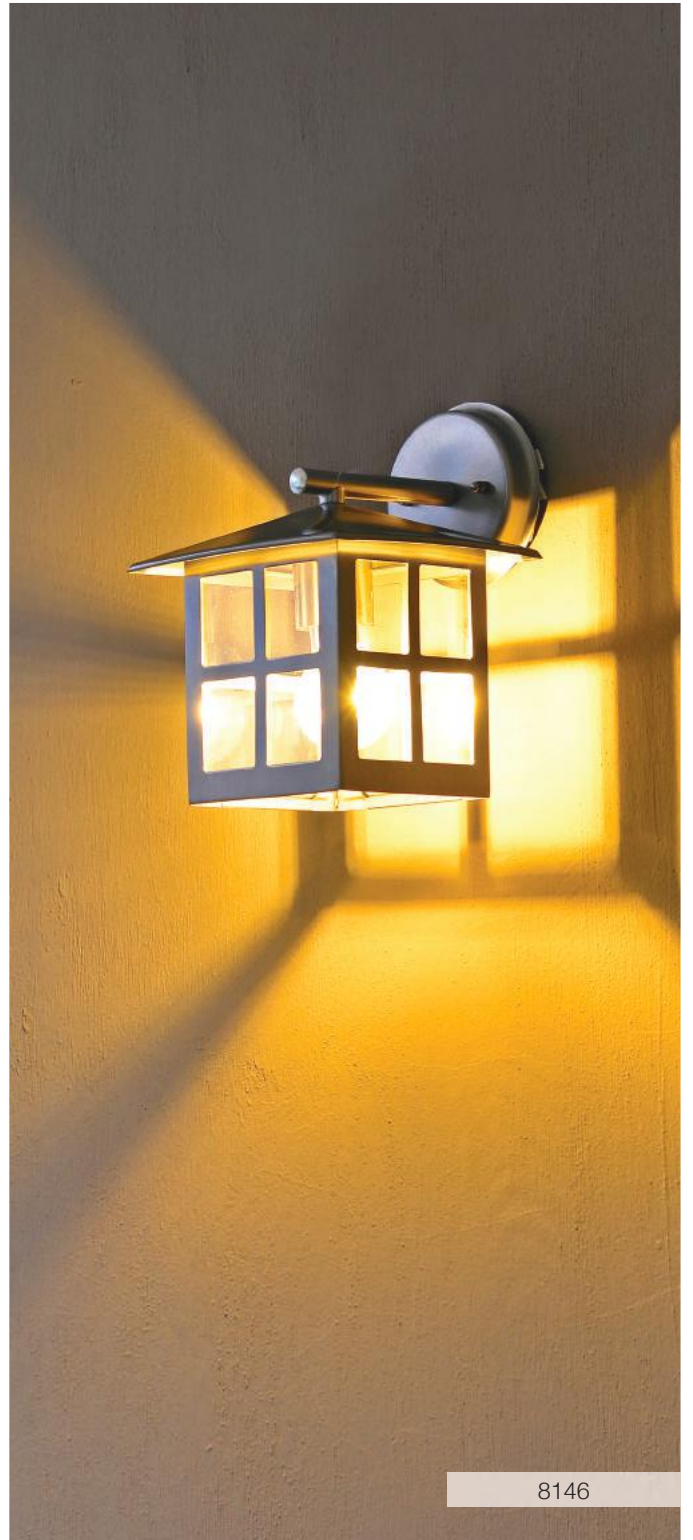
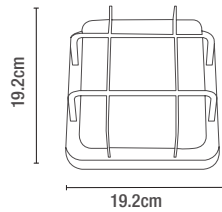

8146



CÓDIGO	DESCRIPCIÓN	USO	MATERIA PRIMA	TERMINADO	POTENCIA MÁX (W)	VOLTAJE	VAC-Hz	IP	TIPO DE SOCKET	# DE SOCKET
8146	LUMINARIA DE SOBREPONER PARA MURO	EXTERIOR	ACERO INOX / CRISTAL	INOXIDABLE	60 W	127 V~	50-60 Hz	54	E27	1
8148	LUMINARIA DE SOBREPONER PARA MURO	EXTERIOR	ACERO INOX/ CRISTAL	INOXIDABLE	60 W	127 V~	50-60 Hz	54	E27	1

DETALLES QUE ILUMINAN TU NOCHE

Da un toque cálido a
tu ambiente



7031-A

7031-A

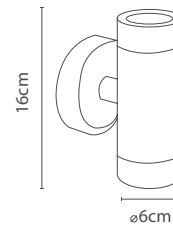

7032-A

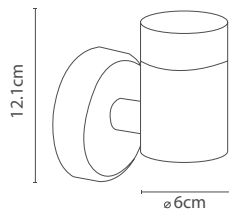

7033-A

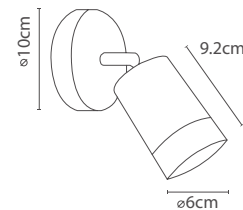

CÓDIGO	DESCRIPCIÓN	USO	MATERIA PRIMA	TERMINADO	POTENCIA MAX (W)	VOLTAJE	VAC-Hz	IP	TIPO DE SOCKET	# DE SOCKET
7031-A	LUMINARIA DE SOBREPONER PARA MURO	EXTERIOR	ACERO INOX	INOXIDABLE	70 W	127 V~	50-60 Hz	54	GU10	2
7032-A	LUMINARIA DE SOBREPONER PARA MURO	EXTERIOR	ACERO INOX	INOXIDABLE	35 W	127 V~	50-60 Hz	54	GU10	1
7033-A	LUMINARIA DIRIGIBLE DE SOBREPONER PARA MURO	EXTERIOR	ACERO INOX	INOXIDABLE	35 W	127 V~	50-60 Hz	54	GU10	1

8101

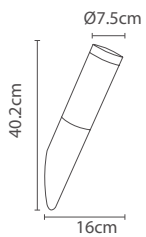

8102

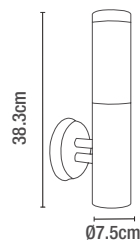

8103-450

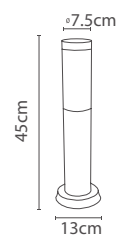

CÓDIGO	DESCRIPCIÓN	USO	MATERIA PRIMA	TERMINADO	POTENCIA MÁX (W)	VOLTAJE	VAC-Hz	IP	TIPO DE SOCKET	# DE SOCKET
8101	LUMINARIA DE SOBREPONER PARA MURO	EXTERIOR	ACERO INOX / POLICARBONATO	INOXIDABLE	40 W	127 V~	50-60 Hz	54	E27	1
8102	LUMINARIA DE SOBREPONER PARA MURO	EXTERIOR	ACERO INOX / POLICARBONATO	INOXIDABLE	40 W	127 V~	50-60 Hz	54	E27	1
8103-450	MINIPOSTE DE SOBREPONER EN PISO	EXTERIOR	ACERO INOX / POLICARBONATO	INOXIDABLE	40 W	127 V~	50-60 Hz	54	E27	1

8112

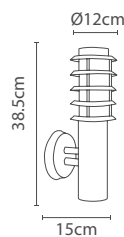

8113-450

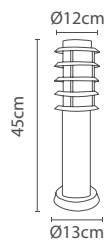

6280

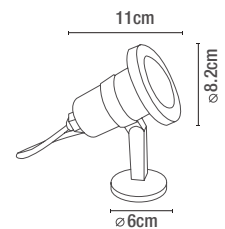

CÓDIGO	DESCRIPCIÓN	USO	MATERIA PRIMA	TERMINADO	POTENCIA MAX (W)	VOLTAJE	VAC-Hz	IP	TIPO DE SOCKET	# DE SOCKET
8112	LUMINARIA DE SOBREPONER PARA MURO	EXTERIOR	ACERO INOX / POLICARBONATO	INOXIDABLE	40 W	127 V~	50-60 Hz	54	E27	1
8113-450	LUMINARIA DE SOBREPONER EN PISO	EXTERIOR	ACERO INOX / POLICARBONATO	INOXIDABLE	40 W	127 V~	50-60 Hz	54	E27	1
6280	LUMINARIA DE SOBREPONER EN PISO	EXTERIOR	ACERO INOX	INOXIDABLE	35 W	127 V~	50-60 Hz	65	GX5.3	1

3180

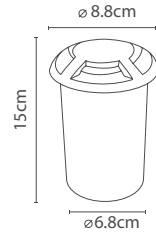

3190

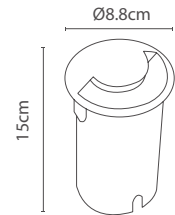

3180

7280

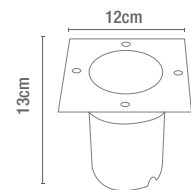

CÓDIGO	DESCRIPCIÓN	USO	MATERIA PRIMA	TERMINADO	POTENCIA MAX (W)	VOLTAJE	VAC-Hz	IP	TIPO DE SOCKET	# DE SOCKET	CORTE DE EMPOTRAMIENTO
3180	LUMINARIA PARA EMPOTRAR EN PISO	EXTERIOR	ACERO INOX	INOXIDABLE	35 W	127 V~	50-60 Hz	65	GU10	1	6.8 cm
3190	LUMINARIA PARA EMPOTRAR EN PISO	EXTERIOR	ACERO INOX	INOXIDABLE	35 W	127 V~	50-60 Hz	65	GU10	1	6.8 cm
7280	LUMINARIA PARA EMPOTRAR EN PISO	EXTERIOR	ACERO INOX	INOXIDABLE	35 W	127 V~	50-60 Hz	67	GU10	1	10.5 cm



7371

7371

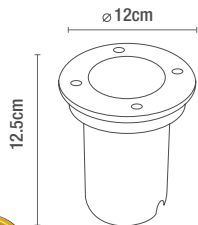

PRODUCTO
NUEVO

7372

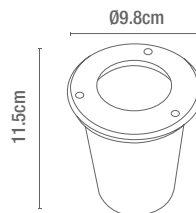

7450

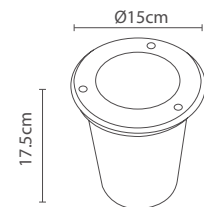

CÓDIGO	DESCRIPCIÓN	USO	MATERIA PRIMA	TERMINADO	POTENCIA MAX (W)	VOLTAJE	VAC-Hz	IP	TIPO DE SOCKET	# DE SOCKET	CORTE DE EMPOTRAMIENTO
7371	LUMINARIA PARA EMPOTRAR EN PISO	EXTERIOR	ACERO INOX	INOXIDABLE	35 W	127 V~	50-60 Hz	65	GU10	1	10.2 cm
7372	LUMINARIA PARA EMPOTRAR EN PISO	EXTERIOR	ACERO INOX	INOXIDABLE	35 W	127 V~	50-60 Hz	65	GU10	1	8.8 cm
7450	LUMINARIA PARA EMPOTRAR EN PISO	EXTERIOR	ACERO INOX	INOXIDABLE	60 W	127 V~	50-60 Hz	65	E27	1	13.8 cm



LÍNEA PRODUCTOS PARA MURO

Iguala la claridad del sol

CALUX®
ILUMINA MEJOR



AS1L/S

AS1L/S

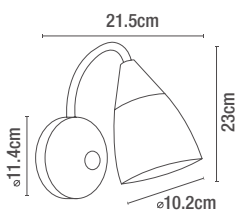

AS1L/CH

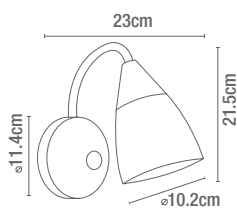

A2028-1/S

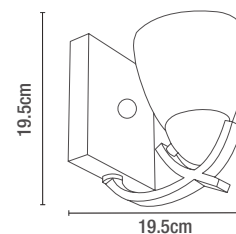

CÓDIGO	DESCRIPCIÓN	USO	MATERIA PRIMA	TERMINADO	POTENCIA MAX (W)	VOLTAJE	VAC-HZ	TIPO DE SOCKET	# DE SOCKET
AS1L/S	LUMINARIA DE SOBREPONER PARA MURO	INTERIOR	ACERO/CRISTAL	SATINADO	60 W	127 V~	50-60 HZ	E27	1
AS1L/CH	LUMINARIA DE SOBREPONER PARA MURO	INTERIOR	ACERO/CRISTAL	CHOCOLATE	60 W	127 V~	50-60 HZ	E27	1
A2028-1/S	LUMINARIA DE SOBREPONER PARA MURO	INTERIOR	ACERO/CRISTAL	SATINADO	60 W	127 V~	50-60 HZ	E27	1

96291

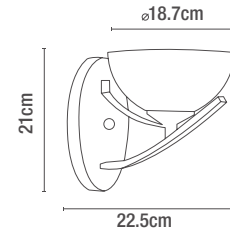

AJB11-12

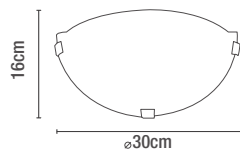

B021

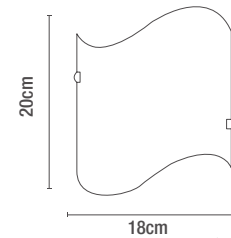

CÓDIGO	DESCRIPCIÓN	USO	MATERIA PRIMA	TERMINADO	POTENCIA MAX (W)	VOLTAJE	VAC-HZ	TIPO DE SOCKET	# DE SOCKET
96291	LUMINARIA DE SOBREPONER PARA MURO	INTERIOR	ACERO/CRISTAL	SATINADO	60 W	127 V~	50-60 HZ	E27	1
AJB11-12	LUMINARIA DE SOBREPONER PARA MURO	INTERIOR	ACERO/CRISTAL	CRISTAL DECORADO	60 W	127 V~	50-60 HZ	E27	1
B021	LUMINARIA DE SOBREPONER PARA MURO	INTERIOR	ACERO/CRISTAL	CRISTAL FROST	60 W	127 V~	50-60 HZ	E27	1

A2028-1/CO

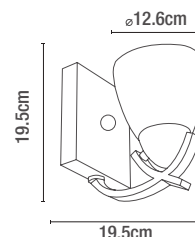

A2029-2/CO

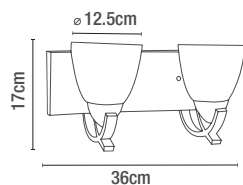

AFK1L/O

Hecho en México

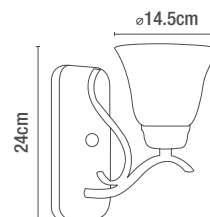

CÓDIGO	DESCRIPCIÓN	USO	MATERIA PRIMA	TERMINADO	POTENCIA MAX (W)	VOLTAJE	VAC-HZ	TIPO DE SOCKET	# DE SOCKET
A2028-1/CO	LUMINARIA DE SOBREPONER PARA MURO	INTERIOR	ACERO/CRISTAL	CAFÉ OSCURO	60 W	127 V~	50-60 HZ	E27	1
A2029-2/CO	LUMINARIA DE SOBREPONER PARA MURO	INTERIOR	ACERO/CRISTAL	CAFÉ OSCURO	120 W	127 V~	50-60 HZ	E27	2
AFK1L/O	LUMINARIA DE SOBREPONER PARA MURO	INTERIOR	ACERO/CRISTAL	OXIDO	60 W	127 V~	50-60 HZ	E27	1

A1081-1

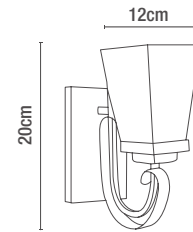

A1082-2

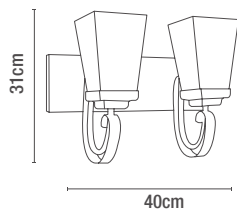

94991/ONIX/O

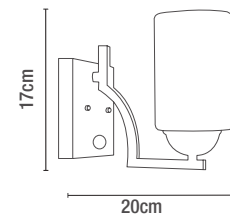

*EL TONO DE LA PIEDRA DE ESTE PRODUCTO PUEDE VARIAR SEGÚN EL LOTE POR SER UN PRODUCTO NATURAL



CÓDIGO	DESCRIPCIÓN	USO	MATERIA PRIMA	TERMINADO	POTENCIA MAX (W)	VOLTAJE	VAC-HZ	TIPO DE SOCKET	# DE SOCKET
A1081-1	LUMINARIA DE SOBREPONER PARA MURO	INTERIOR	ACERO/CRISTAL	VERDE ANTIGUO	60 W	127 V~	50-60 HZ	E27	1
A1082-2	LUMINARIA DE SOBREPONER PARA MURO	INTERIOR	ACERO/CRISTAL	VERDE ANTIGUO	120 W	127 V~	50-60 HZ	E27	2
94991/ONIX/O	LUMINARIA DE SOBREPONER PARA MURO	INTERIOR	ACERO/ONIX	OXIDO	60 W	127 V~	50-60 HZ	E27	1

OXC200/P

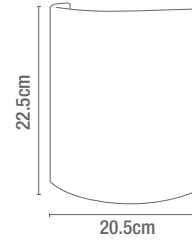

OXC200PQ/P

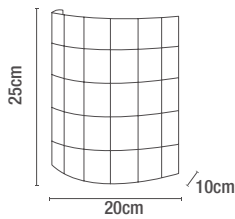

OXC200PQ/B

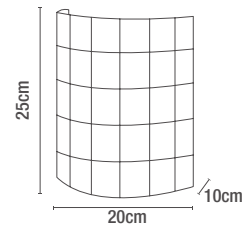

*EL TONO DE LA PIEDRA DE ESTOS PRODUCTO PUEDE VARIAR SEGÚN EL LOTE POR SER UN PRODUCTO NATURAL



CÓDIGO	DESCRIPCIÓN	USO	MATERIA PRIMA	TERMINADO	POTENCIA MÁX (W)	VOLTAJE	VAC-HZ	TIPO DE SOCKET	# DE SOCKET
OXC200/P	LUMINARIA DE SOBREPONER PARA MURO	INTERIOR	ONIX	PIÑA	60 W	127 V~	50-60 HZ	E27	1
OXC200PQ/P	LUMINARIA DE SOBREPONER PARA MURO	INTERIOR	ONIX	PIÑA	60 W	127 V~	50-60 HZ	E27	1
OXC200PQ/B	LUMINARIA DE SOBREPONER PARA MURO	INTERIOR	ONIX	BLANCO	60 W	127 V~	50-60 HZ	E27	1

OXG312/P

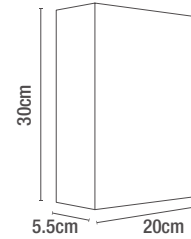

OXG212/P

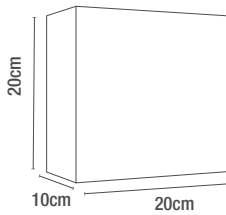

OXC120PQ/P

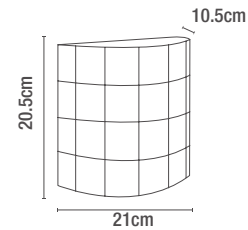

*EL TONO DE LA PIEDRA DE ESTOS PRODUCTO PUEDE VARIAR SEGÚN EL LOTE POR SER UN PRODUCTO NATURAL



CÓDIGO	DESCRIPCIÓN	USO	MATERIA PRIMA	TERMINADO	POTENCIA MAX (W)	VOLTAJE	VAC-HZ	TIPO DE SOCKET	# DE SOCKET
OXG312/P	LUMINARIA DE SOBREPONER PARA MURO	INTERIOR	ONIX	PIÑA	60 W	127 V~	50-60 HZ	E27	1
OXG212/P	LUMINARIA DE SOBREPONER PARA MURO	INTERIOR	ONIX	PIÑA	60 W	127 V~	50-60 HZ	E27	1
OXC120PQ/P	LUMINARIA DE SOBREPONER PARA MURO	INTERIOR	ONIX	PIÑA	60 W	127 V~	50-60 HZ	E27	1



F1090/CR

F1090/CR

F1091/CR

F1092/CR



CÓDIGO	DESCRIPCIÓN	USO	MATERIA PRIMA	TERMINADO	POTENCIA MAX (W)	VOLTAJE	VAC-HZ	TIPO DE SOCKET	# DE SOCKET
F1090/CR	LUMINARIA DE SOBREPONER EN MURO CON LUZ LED DIRIGIBLE Y ENTRADA USB	INTERIOR	ACERO	CROMO	43 W	100-240 V~	50-60 HZ	E27	1
F1091/CR	LUMINARIA DE SOBREPONER EN MURO CON LUZ LED DIRIGIBLE Y ENTRADA USB	INTERIOR	ACERO	CROMO	63 W	100-240 V~	50-60 HZ	E27	1
F1092/CR	LUMINARIA DE SOBREPONER PARA MURO CON LUZ LED DIRIGIBLE Y ENTRADA USB	INTERIOR	ACERO	CROMO	63 W	100-240 V~	50-60 HZ	E27	1

HS-5016-1



HS-5017-2



HS-5018-3



CÓDIGO	DESCRIPCIÓN	USO	MATERIA PRIMA	TERMINADO	POTENCIA MAX (W)	VOLTAJE	VAC-HZ	IP	TIPO DE SOCKET	# DE SOCKET
HS-5016-1	LUMINARIA DE SOBREPONER PARA MURO	INTERIOR	ACERO/CRISTAL	CROMADO	35 W	127 V~	50-60 HZ	20	GU10	1
HS-5017-2	LUMINARIA DE SOBREPONER PARA MURO	INTERIOR	ACERO/CRISTAL	CROMADO	70 W	127 V~	50-60 HZ	20	GU10	2
HS-5018-3	LUMINARIA DE SOBREPONER PARA MURO	INTERIOR	ACERO/CRISTAL	CROMADO	105 W	127 V~	50-60 HZ	20	GU10	3

3112

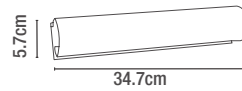

4100

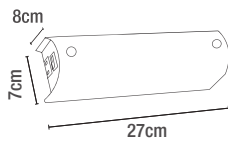
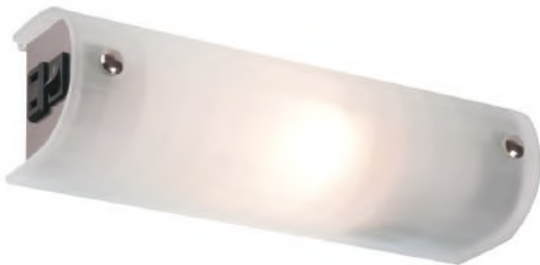

4101

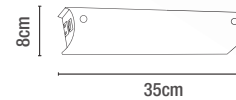

CÓDIGO	DESCRIPCIÓN	USO	MATERIA PRIMA	TERMINADO	POTENCIA MÁX (W)	VOLTAJE	VAC-HZ	TIPO DE SOCKET	# DE SOCKET
3112	LUMINARIA DE SOBREPONER PARA MURO	INTERIOR	ACERO/CRISTAL	CRISTAL DECORADO	80 W	127 V~	50-60 HZ	E27	2
4100	LUMINARIA DE SOBREPONER PARA MURO	INTERIOR	ACERO/CRISTAL	CRISTAL FROST	40 W	127 V~	50-60 HZ	E27	1
4101	LUMINARIA DE SOBREPONER PARA MURO	INTERIOR	ACERO/CRISTAL	CRISTAL FROST	80 W	127 V~	50-60 HZ	E27	2

V22154W/25

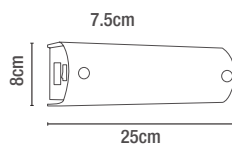

V22154W/35

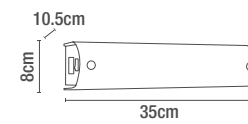

V22154W/65

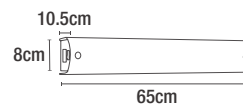

CÓDIGO	DESCRIPCIÓN	USO	MATERIA PRIMA	TERMINADO	POTENCIA MAX (W)	VOLTAJE	VAC-HZ	TIPO DE SOCKET	# DE SOCKET
V22154W/25	LUMINARIA DE SOBREPONER PARA MURO	INTERIOR	ACERO/CRISTAL	CRISTAL FROST	40 W	100-240 V~	50-60 HZ	E27	1
V22154W/35	LUMINARIA DE SOBREPONER PARA MURO	INTERIOR	ACERO/CRISTAL	CRISTAL FROST	80 W	100-240 V~	50-60 HZ	E27	2
V22154W/65	LUMINARIA DE SOBREPONER PARA MURO	INTERIOR	ACERO/CRISTAL	CRISTAL FROST	160 W	100-240 V~	50-60 HZ	E27	4

AM6B

BC6/N

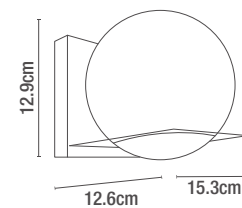
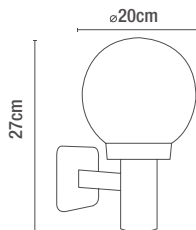

CÓDIGO	DESCRIPCIÓN	USO	MATERIA PRIMA	TERMINADO	POTENCIA MAX (W)	VOLTAJE	VAC-HZ	IP	TIPO DE SOCKET	# DE SOCKET
AM6B	LUMINARIA DE SOBREPONER PARA MURO	EXTERIOR	ACERO/CRISTAL OPALINO	BLANCO	60 W	125 V~	50-60 HZ	54	E27	1
AM6N	LUMINARIA DE SOBREPONER PARA MURO	EXTERIOR	ACERO/CRISTAL OPALINO	NEGRO	60 W	125 V~	50-60 HZ	54	E27	1
BC6/N	LUMINARIA DE SOBREPONER PARA MURO	EXTERIOR	ACERO/CRISTAL OPALINO	NEGRO	60 W	125 V~	50-60 HZ	54	E27	1

ILUMINACIÓN PARA TODOS LOS ESPACIOS

Da la bienvenida con
distintos estilos

AM6B





LÍNEA PLAFONES

Ambienta las escenas de todos los días

CALUX
ILUMINA MEJOR

LUZ SOFISTICADA

Rebela la cotidianidad
con elegancia

P511/CH

P145/CH

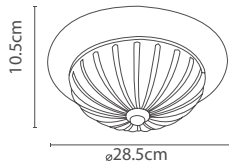

P185/CH

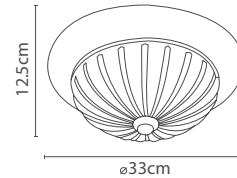

P611/CH

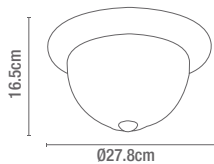

P811/CH

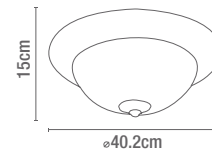

CÓDIGO	DESCRIPCIÓN	USO	MATERIA PRIMA	TERMINADO	POTENCIA MÁX (W)	VOLTAJE	VAC-Hz	TIPO DE SOCKET	# DE SOCKET
P145/CH	LUMINARIA DE SOBREPONER PARA TECHO	INTERIOR	ACERO / CRISTAL	CHOCOLATE	80 W	127 V~	50-60 Hz	E27	2
P185/CH	LUMINARIA DE SOBREPONER PARA TECHO	INTERIOR	ACERO / CRISTAL	CHOCOLATE	80 W	127 V~	50-60 Hz	E27	2
P611/CH	LUMINARIA DE SOBREPONER PARA TECHO	INTERIOR	ACERO / CRISTAL	CHOCOLATE	80 W	127 V~	50-60 Hz	E27	2
P811/CH	LUMINARIA DE SOBREPONER PARA TECHO	INTERIOR	ACERO / CRISTAL	CHOCOLATE	120 W	127 V~	50-60 Hz	E27	2

SPMD/S

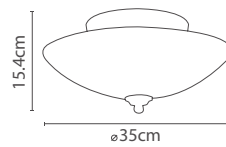

PRODUCTO
NUEVO

PL501-2/GR

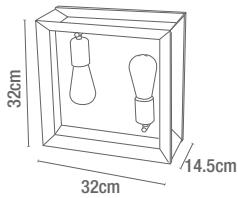

A7732/1

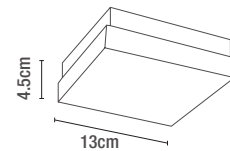

CÓDIGO	DESCRIPCIÓN	USO	MATERIA PRIMA	TERMINADO	POTENCIA MAX (W)	VOLTAJE	VAC-Hz	TIPO DE SOCKET	# DE SOCKET
SPMD/S	LUMINARIA DE SOBREPONER PARA TECHO	INTERIOR	ACERO / CRISTAL	SATINADO	120 W	127 V~	50-60 Hz	E27	2
PL501-2/GR	LUMINARIA DE SOBREPONER PARA TECHO	INTERIOR	ACERO	SATINADO	120 W	127 V~	50-60 Hz	E27	2
A7732/1	LUMINARIA DE SOBREPONER PARA TECHO	INTERIOR	ACERO / CRISTAL ACIDO	GRIS	40 W	127 V~	50-60 Hz	G9	1

JB11-9

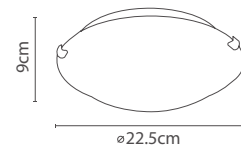

JB11-12

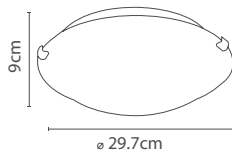

JB11-16

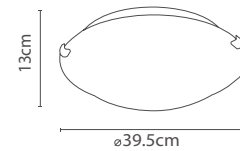

CÓDIGO	DESCRIPCIÓN	USO	MATERIA PRIMA	TERMINADO	POTENCIA MÁX (W)	VOLTAJE	VAC-Hz	TIPO DE SOCKET	# DE SOCKET
JB11-9	LUMINARIA DE SOBREPONER PARA TECHO	INTERIOR	ACERO / CRISTAL	SATINADO	60 W	127 V~	50-60 Hz	E27	1
JB11-12	LUMINARIA DE SOBREPONER PARA TECHO	INTERIOR	ACERO / CRISTAL	SATINADO	60 W	127 V~	50-60 Hz	E27	1
JB11-16	LUMINARIA DE SOBREPONER PARA TECHO	INTERIOR	ACERO / CRISTAL	SATINADO	120 W	127 V~	50-60 Hz	E27	2

BL24-CH

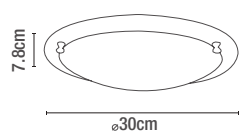

BL24

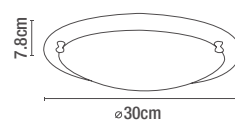

BL24WH

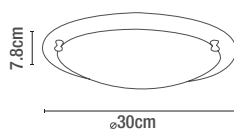

CÓDIGO	DESCRIPCIÓN	USO	MATERIA PRIMA	TERMINADO	POTENCIA MÁX (W)	VOLTAJE	VAC-Hz	TIPO DE SOCKET	# DE SOCKET
BL24	LUMINARIA DE SOBREPONER PARA TECHO	INTERIOR	ACERO / CRISTAL	SATINADO	60 W	127 V~	50-60 Hz	E27	1
BL24-CH	LUMINARIA DE SOBREPONER PARA TECHO	INTERIOR	ACERO / CRISTAL	CHOCOLATE	60 W	127 V~	50-60 Hz	E27	1
BL24WH	LUMINARIA DE SOBREPONER PARA TECHO	INTERIOR	ACERO / CRISTAL	BLANCO	60 W	127 V~	50-60 Hz	E27	1

NE350/S



N450B



N850B

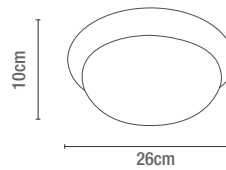
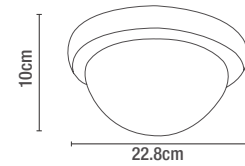
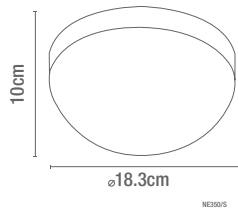

AE714/B



BR6/B

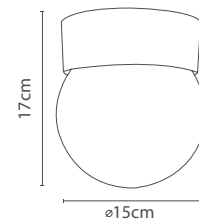
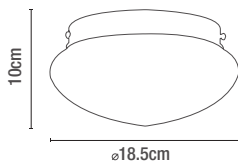

CÓDIGO	DESCRIPCIÓN	USO	MATERIA PRIMA	TERMINADO	POTENCIA MAX (W)	VOLTAJE	VAC-Hz	TIPO DE SOCKET	# DE SOCKET
NE350/S NE350/B	LUMINARIA DE SOBREPONER PARA TECHO	INTERIOR	ACERO / CRISTAL OPALINO	SATINADO BLANCO	60 W	127 V~	50-60 Hz	E27	1
N450B N450S	LUMINARIA DE SOBREPONER PARA TECHO	INTERIOR	ACERO / CRISTAL OPALINO	BLANCO SATINADO	60 W	127 V~	50-60 Hz	E27	1
N850B N850S	LUMINARIA DE SOBREPONER PARA TECHO	INTERIOR	ACERO / CRISTAL OPALINO	BLANCO SATINADO	60 W	127 V~	50-60 Hz	E27	1
AE714/B AE714/N	LUMINARIA DE SOBREPONER PARA TECHO	INTERIOR	ALUMINIO / CRISTAL OPALINO	BLANCO NEGRO	60 W	127 V~	50-60 Hz	E27	1
BR6/B BR6/N	LUMINARIA DE SOBREPONER PARA TECHO	INTERIOR	ALUMINIO / CRISTAL OPALINO	BLANCO NEGRO	60 W	127 V~	50-60 Hz	E27	1





LÍNEA PRODUCTOS PARA TECHO

Luminaria a la medida de tus deseos

**CALUX**
ILUMINA MEJOR

HS-5015-1/BL

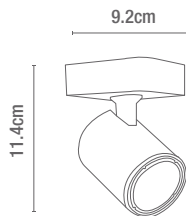

HS-5015-2/BL

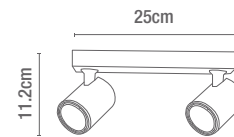

HS-5015-3/BL

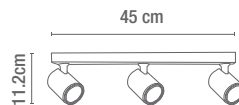

CÓDIGO	DESCRIPCIÓN	USO	MATERIA PRIMA	TERMINADO	POTENCIA MÁX (W)	VOLTAJE	VAC-Hz	TIPO DE SOCKET	# DE SOCKET
HS-5015-1/BL	LUMINARIA DIRIGIBLE DE SOBREPONER PARA TECHO	INTERIOR	ALUMINIO/ALUMINIO	BLANCO	35 W	100-240 V~	50-60 Hz	GU10	1
HS-5015-2/BL	LUMINARIA DIRIGIBLE DE SOBREPONER PARA TECHO	INTERIOR	ALUMINIO/ALUMINIO	BLANCO	70 W	100-240 V~	50-60 Hz	GU10	2
HS-5015-3/BL	LUMINARIA DIRIGIBLE DE SOBREPONER PARA TECHO	INTERIOR	ALUMINIO/ALUMINIO	BLANCO	105 W	100-240 V~	50-60 Hz	GU10	3

HS-5013-3

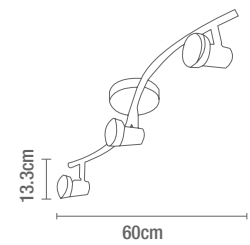

HS-5028-3

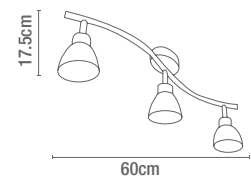

CÓDIGO	DESCRIPCIÓN	USO	MATERIA PRIMA	TERMINADO	POTENCIA MÁX (W)	VOLTAJE	VAC-Hz	TIPO DE SOCKET	# DE SOCKET
HS-5013-3	LUMINARIA DIRIGIBLE DE SOBREPONER PARA TECHO	INTERIOR	ACERO	SATINADO	105 W	127 V~	50-60 Hz	GU10	3
HS-5028-3	LUMINARIA DE SOBREPONER PARA TECHO	INTERIOR	ACERO/ CRISTAL	SATINADO	120 W	127 V~	50-60 Hz	G9	3



C2035-3/CR

PRODUCTO
NUEVO

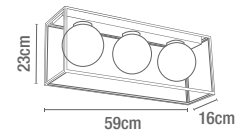

C210/CC

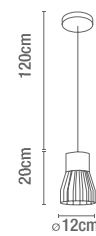

CÓDIGO	DESCRIPCIÓN	USO	MATERIA PRIMA	TERMINADO	POTENCIA MÁX (W)	VOLTAJE	VAC-Hz	TIPO DE SOCKET	# DE SOCKET
C2035-3/NE	LUMINARIA DE SOBREPONER PARA TECHO	INTERIOR	ACERO/CRISTAL	NEGRO	120 W	125 V~	50-60 Hz	E27	3
C2035-3/CR	LUMINARIA DE SOBREPONER PARA TECHO	INTERIOR	ACERO/CRISTAL	CROMO	120 W	125 V~	50-60 Hz	E27	3
C210/CC	LUMINARIA COLGANTE PARA TECHO	INTERIOR	ACERO / CONCRETO	CONCRETO GRIS	40 W	125 V~	50-60 Hz	E27	1

C093/HU

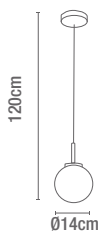

C093/C

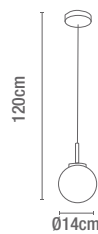

C094/CR

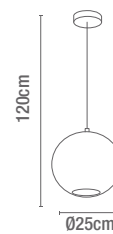

CÓDIGO	DESCRIPCIÓN	USO	MATERIA PRIMA	TERMINADO	POTENCIA MÁX (W)	VOLTAJE	VAC-Hz	TIPO DE SOCKET	# DE SOCKET
C093/HU	LUMINARIA COLGANTE PARA TECHO	INTERIOR	ACERO/CRISTAL	HUMO	9 W	125 V~	50-60 Hz	G9	1
C093/C	LUMINARIA COLGANTE PARA TECHO	INTERIOR	ACERO/CRISTAL	TRASLUCIDO	9 W	125 V~	50-60 Hz	G9	1
C094/CR	LUMINARIA COLGANTE PARA TECHO	INTERIOR	ACERO	CROMO	40 W	125 V~	50-60 Hz	E27	1

V2028

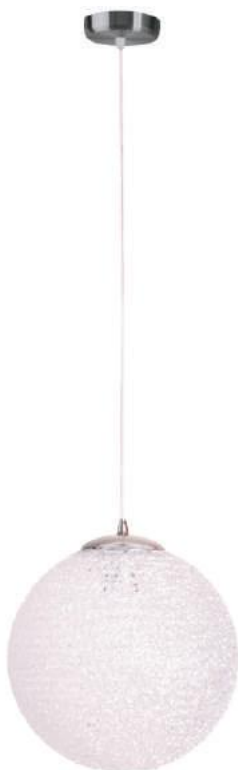

C050/CA



C095/S

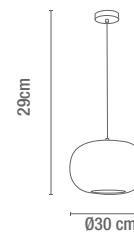
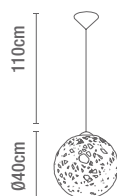
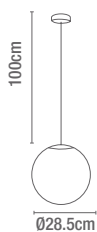
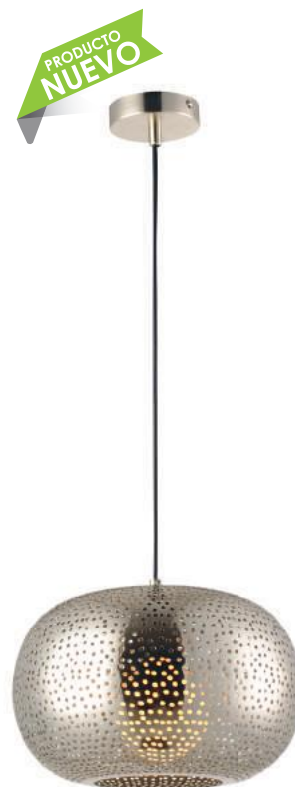

CÓDIGO	DESCRIPCIÓN	USO	MATERIA PRIMA	TERMINADO	POTENCIA MAX (W)	VOLTAJE	VAC-Hz	TIPO DE SOCKET	# DE SOCKET
V2028	LUMINARIA COLGANTE PARA TECHO	INTERIOR	ACERO/ACRÍLICO	CRISTAL	60 W	127 V~	50-60 Hz	E27	1
C050/CA	LUMINARIA COLGANTE PARA TECHO	INTERIOR	PAPEL	CAFÉ	60 W	127 V~	50-60 Hz	E27	1
C095/S	LUMINARIA COLGANTE PARA TECHO	INTERIOR	ACERO	SATINADO	40 W	125 V~	50-60 Hz	E27	1

C010/NE

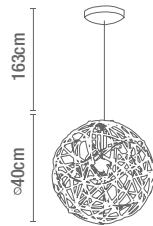

C020/CO

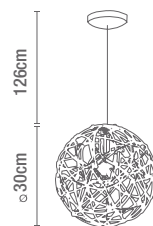

CÓDIGO	DESCRIPCIÓN	USO	MATERIA PRIMA	TERMINADO	POTENCIA MÁX (W)	VOLTAJE	VAC-Hz	TIPO DE SOCKET	# DE SOCKET
C010/NE	LUMINARIA COLGANTE PARA TECHO	INTERIOR	ACERO/ACRÍLICO	NEGRO	60 W	127 V~	50-60 Hz	E27	1
C020/CO	LUMINARIA COLGANTE PARA TECHO	INTERIOR	ACERO/ACRÍLICO	COBRE	60 W	127 V~	50-60 Hz	E27	1

C228/CGR

V2046/OR

C091/HU

C091/AB

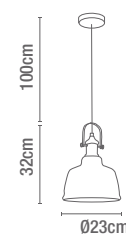
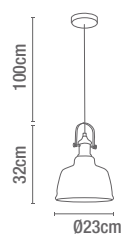
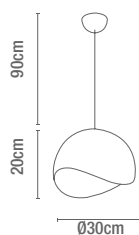
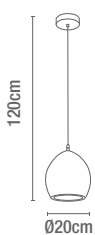

CÓDIGO	DESCRIPCIÓN	USO	MATERIA PRIMA	TERMINADO	POTENCIA MAX (W)	VOLTAJE	VAC-Hz	TIPO DE SOCKET	# DE SOCKET
C228/CGR	LUMINARIA COLGANTE PARA TECHO	INTERIOR	ACERO/CONCRETO	GRIS	60 W	125 V~	50-60 Hz	E27	1
V2046/OR	LUMINARIA COLGANTE PARA TECHO	INTERIOR	ACERO	ORO ROSADO	60 W	127 V~	50-60 Hz	E27	1
C091/HU	LUMINARIA COLGANTE PARA TECHO	INTERIOR	ACERO/CRISTAL	HUMO Y LATON	40 W	125 V~	50-60 Hz	E27	1
C091/AB	LUMINARIA COLGANTE PARA TECHO	INTERIOR	ACERO/CRISTAL	AMBAR Y LATON	40 W	125 V~	50-60 Hz	E27	1

V2020

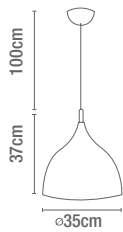

V2032

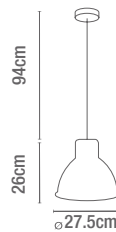

V2050

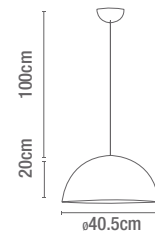

CÓDIGO	DESCRIPCIÓN	USO	MATERIA PRIMA	TERMINADO	POTENCIA MAX (W)	VOLTAJE	VAC-Hz	TIPO DE SOCKET	# DE SOCKET
V2020	LUMINARIA COLGANTE PARA TECHO	INTERIOR	ACERO	CROMADO	60 W	127 V~	50-60 Hz	E27	1
V2032	LUMINARIA COLGANTE PARA TECHO	INTERIOR	ACERO	CONCRETO	60 W	127 V~	50-60 Hz	E27	1
V2050	LUMINARIA COLGANTE PARA TECHO	INTERIOR	ACERO	BLANCO	60 W	127 V~	50-60 Hz	E27	1



C214/AN

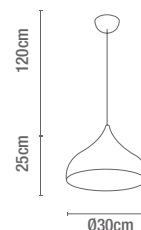

C215/OR

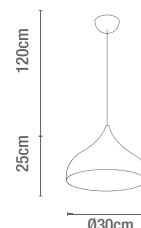

CÓDIGO	DESCRIPCIÓN	USO	MATERIA PRIMA	TERMINADO	POTENCIA MÁX (W)	VOLTAJE	VAC-Hz	TIPO DE SOCKET	# DE SOCKET
C214/AN	LUMINARIA COLGANTE PARA TECHO	INTERIOR	ACERO	ANTIQUE	40 W	127 V~	50-60 Hz	E27	1
C215/OR	LUMINARIA COLGANTE PARA TECHO	INTERIOR	ACERO	ORO ROSADO	40 W	127 V~	50-60 Hz	E27	1



C070/AB

C070/AB

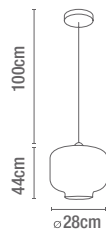

C072/AB

PRODUCTO
NUEVO

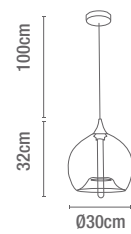

CÓDIGO	DESCRIPCIÓN	USO	MATERIA PRIMA	TERMINADO	POTENCIA MÁX (W)	VOLTAJE	VAC-Hz	TIPO DE SOCKET	# DE SOCKET
C070/AB	LUMINARIA COLGANTE PARA TECHO	INTERIOR	ACERO/CRISTAL	AMBAR	40 W	125 V~	50-60 Hz	E27	1
C072/AB	LUMINARIA COLGANTE PARA TECHO	INTERIOR	ACERO/CRISTAL	AMBAR	40 W	125 V~	50-60 Hz	E27	1

C090/HU



C071/AB



C217/ORM

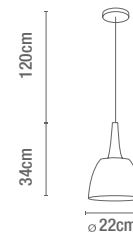
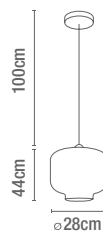
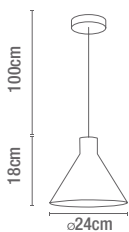

CÓDIGO	DESCRIPCIÓN	USO	MATERIA PRIMA	TERMINADO	POTENCIA MAX (W)	VOLTAJE	VAC-Hz	TIPO DE SOCKET	# DE SOCKET
C090/HU	LUMINARIA COLGANTE PARA TECHO	INTERIOR	ACERO/CRISTAL	GRIS HUMO	40 W	125 V~	50-60 Hz	E27	1
C071/AB	LUMINARIA COLGANTE PARA TECHO	INTERIOR	ACERO/CRISTAL	AMBAR	40 W	125 V~	50-60 Hz	E27	1
C217/ORM	LUMINARIA COLGANTE PARA TECHO	INTERIOR	ACERO/ROBLE	CHAMPAGNE	40 W	125 V~	50-60 Hz	E27	1



C218/ORM

C218/ORM

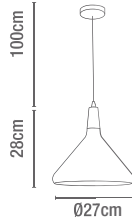

C218/BL

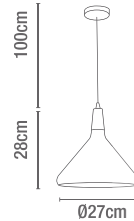

V2054

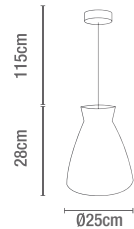

CÓDIGO	DESCRIPCIÓN	USO	MATERIA PRIMA	TERMINADO	POTENCIA MÁX (W)	VOLTAJE	VAC-Hz	TIPO DE SOCKET	# DE SOCKET
C218/ORM	LUMINARIA COLGANTE PARA TECHO	INTERIOR	ALUMINIO/ALUMINIO	CHAMPAGNE	40 W	125 V~	50-60 Hz	E27	1
C218/BL	LUMINARIA COLGANTE PARA TECHO	INTERIOR	ALUMINIO/ALUMINIO	BLANCO MATE	40 W	125 V~	50-60 Hz	E27	1
V2054	LUMINARIA COLGANTE PARA TECHO	INTERIOR	ACERO	MADERA	60 W	127 V~	50-60 Hz	E27	1

V2024/MAD

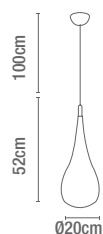

V2024/NEG

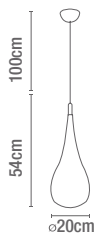

CÓDIGO	DESCRIPCIÓN	USO	MATERIA PRIMA	TERMINADO	POTENCIA MAX (W)	VOLTAJE	VAC-Hz	TIPO DE SOCKET	# DE SOCKET
V2024/MAD	LUMINARIA COLGANTE PARA TECHO	INTERIOR	ACERO	MADERA	60 W	127 V~	50-60 Hz	E27	1
V2024/NEG	LUMINARIA COLGANTE PARA TECHO	INTERIOR	ACERO	NEGRO	60 W	127 V~	50-60 Hz	E27	1



V2024

V2024

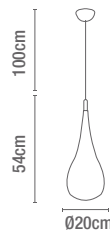

V2022

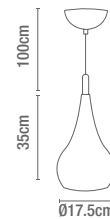

CÓDIGO	DESCRIPCIÓN	USO	MATERIA PRIMA	TERMINADO	POTENCIA MÁX (W)	VOLTAJE	VAC-Hz	TIPO DE SOCKET	# DE SOCKET
V2024	LUMINARIA COLGANTE PARA TECHO	INTERIOR	ACERO	CROMO	60 W	127 V~	50-60 Hz	E27	1
V2022	LUMINARIA COLGANTE PARA TECHO	INTERIOR	ACERO	CROMO	60 W	127 V~	50-60 Hz	E27	1

C077/NE

PRODUCTO
NUEVO

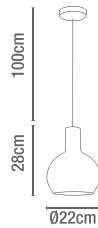

C077/NE-3

PRODUCTO
NUEVO

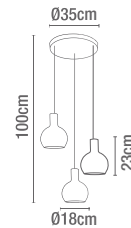

CÓDIGO	DESCRIPCIÓN	USO	MATERIA PRIMA	TERMINADO	POTENCIA MÁX (W)	VOLTAJE	VAC-Hz	TIPO DE SOCKET	# DE SOCKET
C077/NE	LUMINARIA COLGANTE PARA TECHO	INTERIOR	ACERO	NEGRO MATE	40 W	125 V~	50-60 Hz	E27	1
C077/NE-3	LUMINARIA COLGANTE PARA TECHO	INTERIOR	ACERO	NEGRO MATE	120 W	125 V~	50-60 Hz	E27	3

C2030-8/NE

PRODUCTO
NUEVO

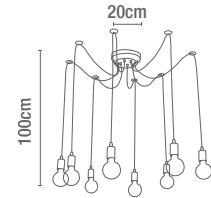

C111/CO

PRODUCTO
NUEVO

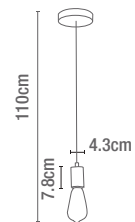

CÓDIGO	DESCRIPCIÓN	USO	MATERIA PRIMA	TERMINADO	POTENCIA MÁX (W)	VOLTAJE	VAC-Hz	TIPO DE SOCKET	# DE SOCKET
C2030-8/NE	LUMINARIA COLGANTE PARA TECHO	INTERIOR	ACERO	NEGRO	320 W	125 V~	50-60 Hz	E27	8
C111/CO	LUMINARIA COLGANTE PARA TECHO	INTERIOR	ALUMINIO	COBRE	40 W	125 V~	50-60 Hz	E27	1



C2036-10/NE

C2036-10/NE



C084/NE



CÓDIGO	DESCRIPCIÓN	USO	MATERIA PRIMA	TERMINADO	POTENCIA MÁX (W)	VOLTAJE	VAC-Hz	TIPO DE SOCKET	# DE SOCKET
C2036-10/NE	LUMINARIA COLGANTE PARA TECHO	INTERIOR	ACERO	NEGRO	400 W	127 V~	50-60 Hz	E27	10
C084/NE	LUMINARIA COLGANTE PARA TECHO	INTERIOR	ACERO	NEGRO MATE	60 W	100-240 V~	50-60 Hz	E27	1

C2029-5/GR

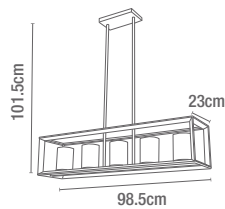

C2031-4/GR

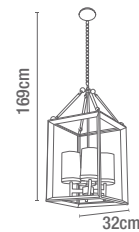

CÓDIGO	DESCRIPCIÓN	USO	MATERIA PRIMA	TERMINADO	POTENCIA MÁX (W)	VOLTAJE	VAC-Hz	TIPO DE SOCKET	# DE SOCKET
C2029-5/GR	LUMINARIA COLGANTE PARA TECHO	INTERIOR	ACERO/CRISTAL	GRIS	300 W	127 V~	50-60 Hz	E27	5
C2031-4/GR	LUMINARIA COLGANTE PARA TECHO	INTERIOR	ACERO/CRISTAL	GRIS	240 W	127 V~	50-60 Hz	E27	4



V2023

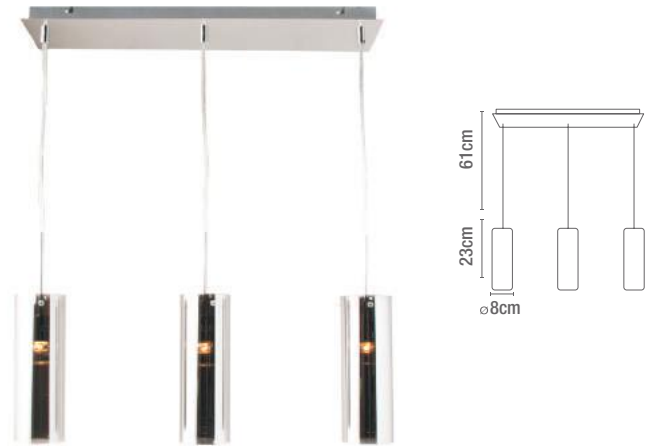

V2025

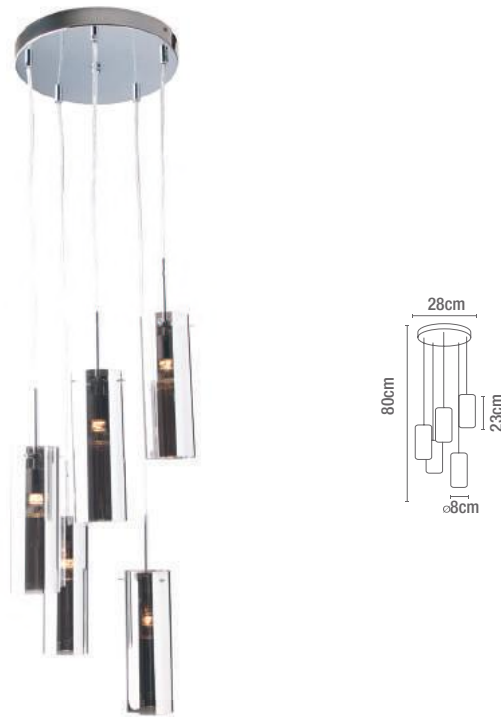

CÓDIGO	DESCRIPCIÓN	USO	MATERIA PRIMA	TERMINADO	POTENCIA MAX (W)	VOLTAJE	VAC-Hz	TIPO DE SOCKET	# DE SOCKET
V2023	LUMINARIA COLGANTE PARA TECHO	INTERIOR	ACERO/CRISTAL	CROMO	105 W	127 V~	50-60 Hz	GU10	3
V2025	LUMINARIA COLGANTE PARA TECHO	INTERIOR	ACERO/CRISTAL	CROMO	175 W	127 V~	50-60 Hz	GU10	5

V2021

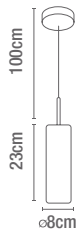

C092/CR

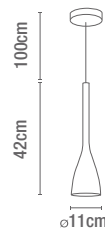

C225/BL

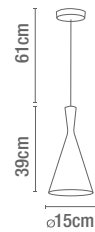

CÓDIGO	DESCRIPCIÓN	USO	MATERIA PRIMA	TERMINADO	POTENCIA MÁX (W)	VOLTAJE	VAC-Hz	TIPO DE SOCKET	# DE SOCKET
V2021	LUMINARIA COLGANTE PARA TECHO	INTERIOR	ACERO/CRISTAL	CROMO	35 W	127 V~	50-60 Hz	GU10	1
C092/CR	LUMINARIA COLGANTE PARA TECHO	INTERIOR	ACERO/CRISTAL	CROMO	25 W	125 V~	50-60 Hz	E27	1
C225/BL	LUMINARIA COLGANTE PARA TECHO	INTERIOR	ALUMINIO/ALUMINIO	BLANCO	40 W	125 V~	50-60 Hz	E27	1

C221/BL

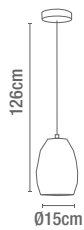

C222/BL

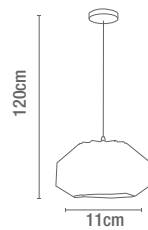

C229/BL

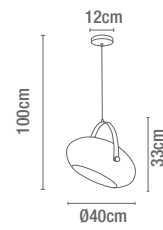

CÓDIGO	DESCRIPCIÓN	USO	MATERIA PRIMA	TERMINADO	POTENCIA MÁX (W)	VOLTAJE	VAC-Hz	TIPO DE SOCKET	# DE SOCKET
C221/BL	LUMINARIA COLGANTE PARA TECHO	INTERIOR	ACERO	BLANCO	40 W	125 V~	50-60 Hz	E27	1
C222/BL	LUMINARIA COLGANTE PARA TECHO	INTERIOR	ACERO	BLANCO	40 W	125 V~	50-60 Hz	E27	1
C229/BL	LUMINARIA COLGANTE PARA TECHO	INTERIOR	ALUMINIO	BLANCO	40 W	125 V~	50-60 Hz	E27	1

C226/BL

C226/NE

C223/NE

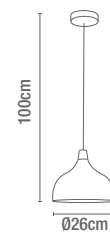
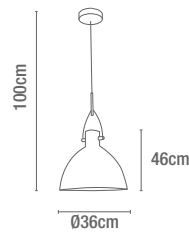
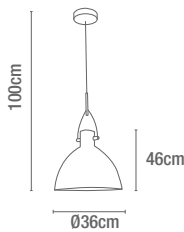
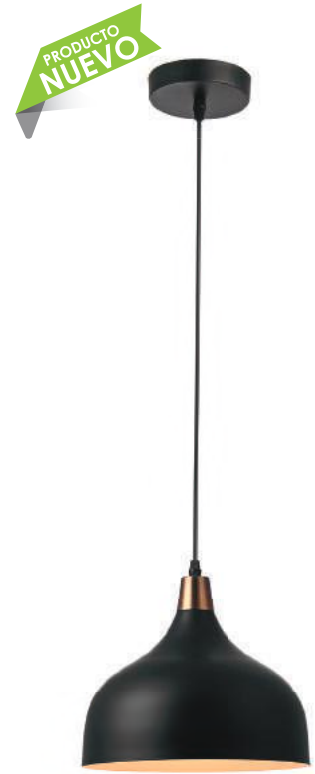

CÓDIGO	DESCRIPCIÓN	USO	MATERIA PRIMA	TERMINADO	POTENCIA MÁX (W)	VOLTAJE	VAC-Hz	TIPO DE SOCKET	# DE SOCKET
C226/BL	LUMINARIA COLGANTE PARA TECHO	INTERIOR	ACERO	BLANCO	40 W	125 V~	50-60 Hz	E27	1
C226/NE	LUMINARIA COLGANTE PARA TECHO	INTERIOR	ACERO	NEGRO	40 W	125 V~	50-60 Hz	E27	1
C223/NE	LUMINARIA COLGANTE PARA TECHO	INTERIOR	ACERO	NEGRO	40 W	125 V~	50-60 Hz	E27	1



C227/NE

C227/NE

PRODUCTO
NUEVO

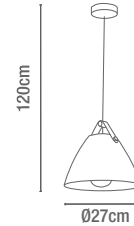

C227/BL

PRODUCTO
NUEVO

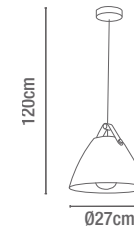

CÓDIGO	DESCRIPCIÓN	USO	MATERIA PRIMA	TERMINADO	POTENCIA MÁX (W)	VOLTAJE	VAC-Hz	TIPO DE SOCKET	# DE SOCKET
C227/NE	LUMINARIA COLGANTE PARA TECHO	INTERIOR	ACERO/ACERO	NEGRO MATE	25 W	125 V~	50-60 Hz	E27	1
C227/BL	LUMINARIA COLGANTE PARA TECHO	INTERIOR	ACERO/ACERO	BLANCO MATE	25 W	125 V~	50-60 Hz	E27	1



C219/NE

C219/BL

C219/NE

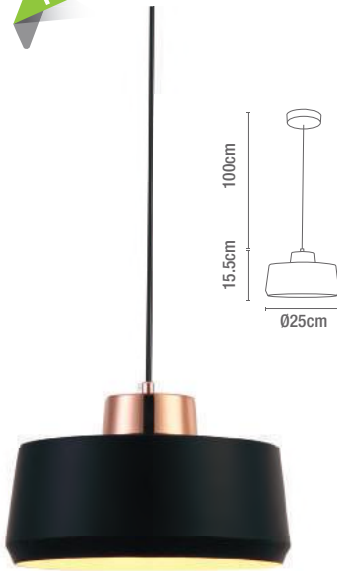

CÓDIGO	DESCRIPCIÓN	USO	MATERIA PRIMA	TERMINADO	POTENCIA MÁX (W)	VOLTAJE	VAC-Hz	TIPO DE SOCKET	# DE SOCKET
C219/BL	LUMINARIA COLGANTE PARA TECHO	INTERIOR	ACERO	BLANCO	40 W	125 V~	50-60 Hz	E27	1
C219/NE	LUMINARIA COLGANTE PARA TECHO	INTERIOR	ACERO	NEGRO	40 W	125 V~	50-60 Hz	E27	1

C224/AZ

C224/VE

C224/RO

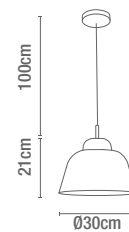
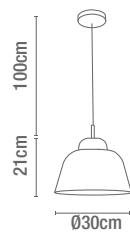
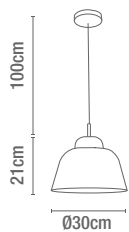

CÓDIGO	DESCRIPCIÓN	USO	MATERIA PRIMA	TERMINADO	POTENCIA MAX (W)	VOLTAJE	VAC-Hz	TIPO DE SOCKET	# DE SOCKET
C224/AZ	LUMINARIA COLGANTE PARA TECHO	INTERIOR	ACERO	AZUL	40 W	125 V~	50-60 Hz	E27	1
C224/VE	LUMINARIA COLGANTE PARA TECHO	INTERIOR	ACERO	VERDE	40 W	125 V~	50-60 Hz	E27	1
C224/RO	LUMINARIA COLGANTE PARA TECHO	INTERIOR	ACERO	ROSA	40 W	125 V~	50-60 Hz	E27	1

C061/NE

C060/NE

C097/CC

PRODUCTO
NUEVO

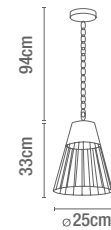
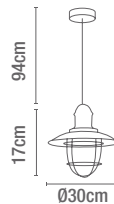
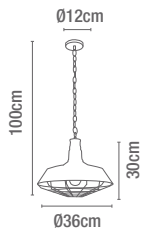

CÓDIGO	DESCRIPCIÓN	USO	MATERIA PRIMA	TERMINADO	POTENCIA MÁX (W)	VOLTAJE	VAC-Hz	TIPO DE SOCKET	# DE SOCKET
C061/NE	LUMINARIA COLGANTE PARA TECHO	INTERIOR	ACERO	NEGRO MATE	40 W	125 V~	50-60 Hz	E27	1
C060/NE	LUMINARIA COLGANTE PARA TECHO	INTERIOR	ACERO	NEGRO MATE	40 W	125 V~	50-60 Hz	E27	1
C097/CC	LUMINARIA COLGANTE PARA TECHO	INTERIOR	ACERO/ CONCRETO	NEGRO/ CONCRETO AMARILLO	40 W	125 V~	50-60 Hz	E27	1



CÓDIGO	DESCRIPCIÓN	USO	MATERIA PRIMA	TERMINADO	POTENCIA MÁX (W)	VOLTAJE	VAC-Hz	TIPO DE SOCKET	# DE SOCKET
C220/BL	LUMINARIA COLGANTE PARA TECHO	INTERIOR	ACERO	BLANCO	40 W	125 V~	50-60 Hz	E27	1
C220/BL-3	LUMINARIA COLGANTE PARA TECHO	INTERIOR	ACERO	BLANCO	120 W	125 V~	50-60 Hz	E27	3



C079/NE



C079/NE



C081/NE



CÓDIGO	DESCRIPCIÓN	USO	MATERIA PRIMA	TERMINADO	POTENCIA MÁX (W)	VOLTAJE	VAC-Hz	TIPO DE SOCKET	# DE SOCKET
C079/NE	LUMINARIA COLGANTE PARA TECHO	INTERIOR	ACERO	NEGRO MATE	40 W	125 V~	50-60 Hz	E27	1
C081/NE	LUMINARIA COLGANTE PARA TECHO	INTERIOR	ACERO	NEGRO MATE	40 W	125 V~	50-60 Hz	E27	1



C076/NE



C082/NE



C076/NE



CÓDIGO	DESCRIPCIÓN	USO	MATERIA PRIMA	TERMINADO	POTENCIA MÁX (W)	VOLTAJE	VAC-Hz	TIPO DE SOCKET	# DE SOCKET
C082/NE	LUMINARIA COLGANTE PARA TECHO	INTERIOR	ACERO	NEGRO MATE	40 W	125 V~	50-60 Hz	E27	1
C076/NE	LUMINARIA COLGANTE PARA TECHO	INTERIOR	ACERO	NEGRO MATE	40 W	125 V~	50-60 Hz	E27	1

C078/NE

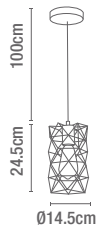

C083/NE

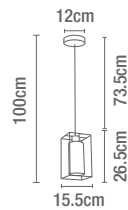
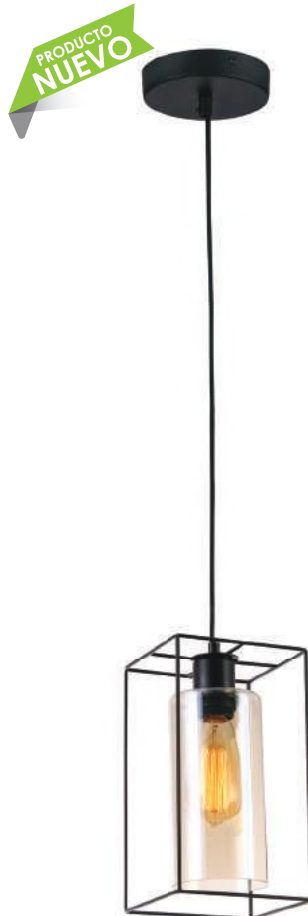

C080/NE

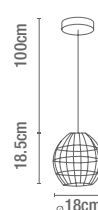

CÓDIGO	DESCRIPCIÓN	USO	MATERIA PRIMA	TERMINADO	POTENCIA MÁX (W)	VOLTAJE	VAC-Hz	TIPO DE SOCKET	# DE SOCKET
C078/NE	LUMINARIA COLGANTE PARA TECHO	INTERIOR	ACERO	NEGRO MATE	40 W	125 V~	50-60 Hz	E27	1
C083/NE	LUMINARIA COLGANTE PARA TECHO	INTERIOR	ACERO/CRISTAL	NEGRO MATE	40 W	125 V~	50-60 Hz	E27	1
C080/NE	LUMINARIA COLGANTE PARA TECHO	INTERIOR	ACERO	NEGRO MATE	40 W	125 V~	50-60 Hz	E27	1



V2042



V2750

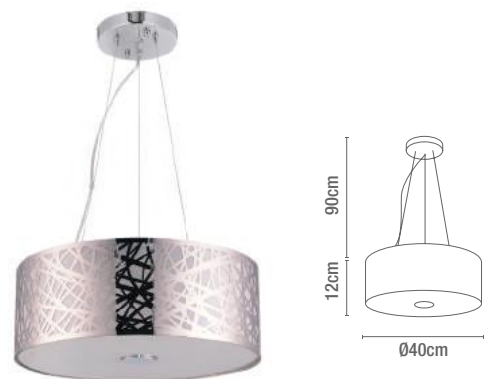

V2740

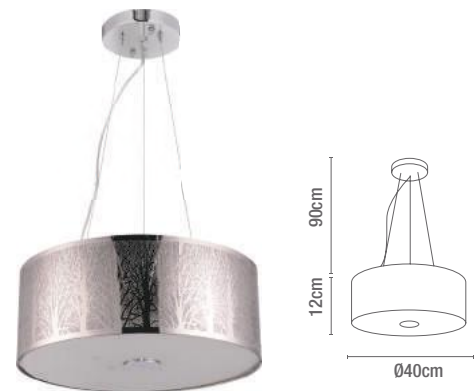

CÓDIGO	DESCRIPCIÓN	USO	MATERIA PRIMA	TERMINADO	POTENCIA MÁX (W)	VOLTAJE	VAC-Hz	TIPO DE SOCKET	# DE SOCKET
V2042	LUMINARIA COLGANTE PARA TECHO	INTERIOR	ACERO/CRISTAL	MADERA	160 W	127 V~	50-60 Hz	E27	4
V2750	LUMINARIA COLGANTE PARA TECHO	INTERIOR	ACERO/CRISTAL	INOX	180 W	127 V~	50-60 Hz	E27	3
V2740	LUMINARIA COLGANTE PARA TECHO	INTERIOR	ACERO/CRISTAL	INOX	180 W	127 V~	50-60 Hz	E27	3

Hecho en México

PIT/S

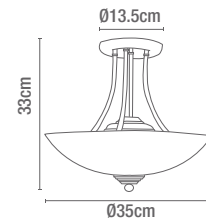

C3C601/AM

Hecho en México

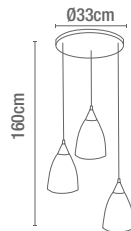

C601/AM

Hecho en México

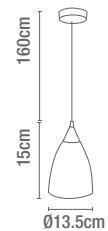

CÓDIGO	DESCRIPCIÓN	USO	MATERIA PRIMA	TERMINADO	POTENCIA MÁX (W)	VOLTAJE	VAC-Hz	TIPO DE SOCKET	# DE SOCKET
PIT/S	LUMINARIA COLGANTE PARA TECHO	INTERIOR	ACERO/CRISTAL ÁCIDO	MARMOL BLANCO	180 W	127 V~	50-60 Hz	E27	3
C3C601/AM	LUMINARIA COLGANTE PARA TECHO	INTERIOR	ALUMINIO/CRISTAL	ALUMINIO MATE / CRISTAL ÁCIDO	180 W	127 V~	50-60 Hz	E27	3
C601/AM	LUMINARIA COLGANTE PARA TECHO	INTERIOR	ALUMINIO/CRISTAL	ALUMINIO MATE/ CRISTAL ÁCIDO	60 W	127 V~	50-60 Hz	E27	1



OXC50/P

V5641/1C

OXC50/P

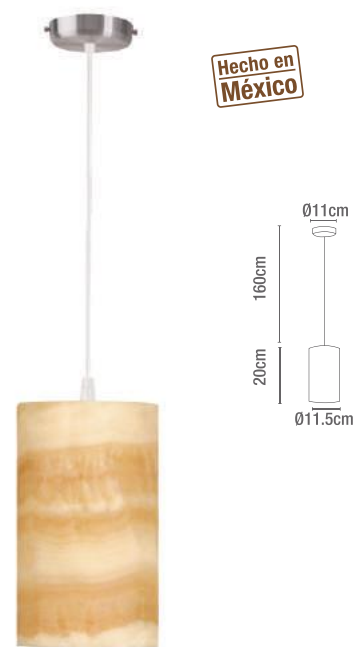
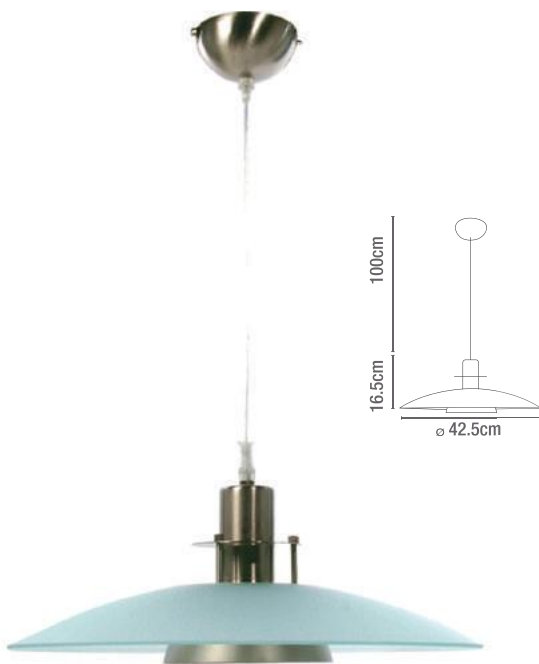

*EL TONO DE LA PIEDRA DE ESTE PRODUCTO PUEDE VARIAR SEGÚN EL LOTE POR SER UN PRODUCTO NATURAL



CÓDIGO	DESCRIPCIÓN	USO	MATERIA PRIMA	TERMINADO	POTENCIA MÁX (W)	VOLTAJE	VAC-Hz	TIPO DE SOCKET	# DE SOCKET
V5641/1C	LUMINARIA COLGANTE PARA TECHO	INTERIOR	ACERO/CRISTAL	SATINADO	60 W	127 V~	50-60 Hz	E27	1
OXC50/P	LUMINARIA COLGANTE PARA TECHO	INTERIOR	ONIX	NATURAL PIÑA	60 W	127 V~	50-60 Hz	E27	1

C401/AM

C901MB/AM

Hecho en México

Hecho en México

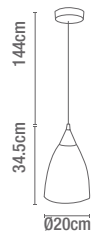
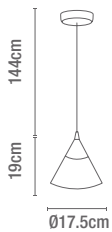

C401/AM



CÓDIGO	DESCRIPCIÓN	USO	MATERIA PRIMA	TERMINADO	POTENCIA MAX (W)	VOLTAJE	VAC-Hz	TIPO DE SOCKET	# DE SOCKET
C401/AM	LUMINARIA COLGANTE PARA TECHO	INTERIOR	ALUMINIO/CRISTAL	ALUMINIO MATE / CRISTAL BLANCO	60 W	127 V~	50-60 Hz	E27	1
C901MB/AM	LUMINARIA COLGANTE PARA TECHO	INTERIOR	ALUMINIO/CRISTAL	ALUMINIO MATE CRISTAL MARMOL BLANCO	60 W	127 V~	50-60 Hz	E27	1

C701MB/AM



C701MC/AM

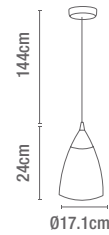
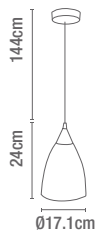

CÓDIGO	DESCRIPCIÓN	USO	MATERIA PRIMA	TERMINADO	POTENCIA MÁX (W)	VOLTAJE	VAC-Hz	TIPO DE SOCKET	# DE SOCKET
C701MB/AM	LUMINARIA COLGANTE PARA TECHO	INTERIOR	ALUMINIO/CRISTAL	ALUMINIO MATE CRISTAL MARMOL BLANCO	60 W	127 V~	50-60 Hz	E27	1
C701MC/AM	LUMINARIA COLGANTE PARA TECHO	INTERIOR	ALUMINIO/CRISTAL	ALUMINIO MATE / CRISTAL MARMOL CAFE	60 W	127 V~	50-60 Hz	E27	1

VINDGD

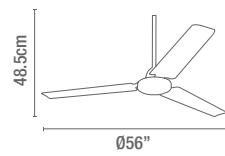

CGDR

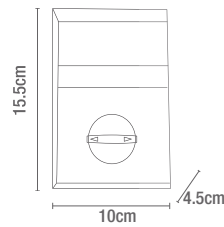

GAVE

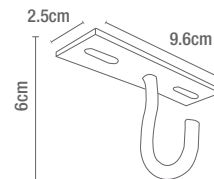

CÓDIGO	DESCRIPCIÓN	USO	MATERIA PRIMA	TERMINADO	POTENCIA MAX (W)	VOLTAJE	VAC-Hz
VINDGD	VENTILADOR	INTERIOR	ACERO	BLANCO	100 W	127 V~	50-60 Hz
CGDR	CONTROL DE VELOCIDAD DE VENTILADOR	INTERIOR	PLÁSTICO	BLANCO	80 W	127 V~	50-60 Hz
GAVE	GANCHO PARA VENTILADOR	INTERIOR	ACERO	DORADO	N/A	N/A	N/A



CANDILES

Detalles para la velada perfecta.

**CALUX**
ILUMINA MEJOR



CFI5L/ONIX/O

CFI5L/ONIX/O

CCF023/ONIX

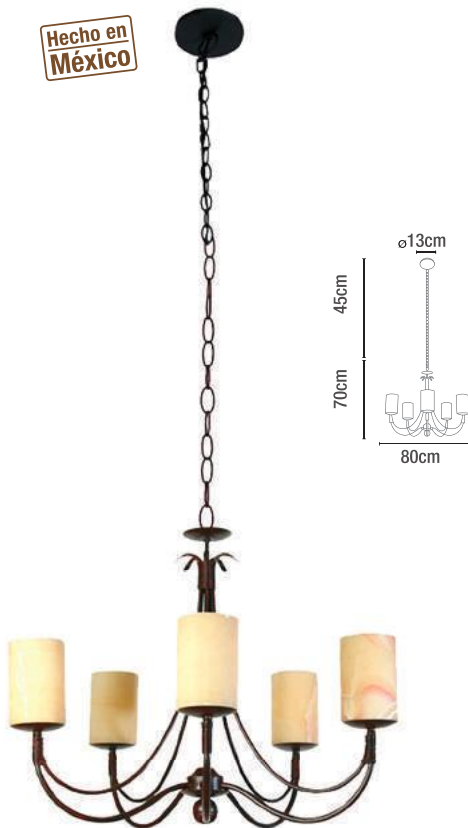

*EL TONO DE LA PIEDRA DE ESTOS PRODUCTOS PUEDE VARIAR SEGÚN EL LOTE POR SER UN PRODUCTO NATURAL

CÓDIGO	DESCRIPCIÓN	USO	MATERIA PRIMA	TERMINADO	POTENCIA MÁX (W)	VOLTAJE	VAC-Hz	TIPO DE SOCKET	# DE SOCKET
CFI5L/ONIX/O	CANDIL SUSPENDIDO	INTERIOR	ACERO FORJADO/ÓNIX	OXIDO	300 W	127 V~	50-60 Hz	E27	5
CCF023/ONIX	CANDIL SUSPENDIDO	INTERIOR	ACERO/ÓNIX	CHOCOLATE	180 W	127 V~	50-60 Hz	E27	3

CFI9L/ONIX/O



CFW6L/ONIX/O



CFI12L/ONIX/O

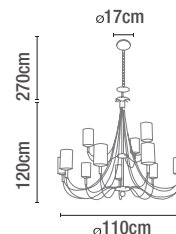
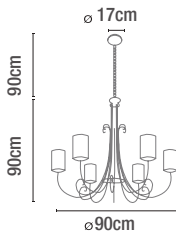
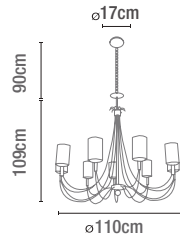

*EL TONO DE LA PIEDRA DE ESTOS PRODUCTOS PUEDE VARIAR SEGÚN EL LOTE POR SER UN PRODUCTO NATURAL

CÓDIGO	DESCRIPCIÓN	USO	MATERIA PRIMA	TERMINADO	POTENCIA MÁX (W)	VOLTAJE	VAC-Hz	TIPO DE SOCKET	# DE SOCKET
CFW6L/ONIX/O	CANDIL SUSPENDIDO	INTERIOR	ACERO FORJADO/ÓNIX	OXIDO	360 W	127 V~	50-60 Hz	E27	6
CFI9L/ONIX/O	CANDIL SUSPENDIDO	INTERIOR	ACERO FORJADO/ÓNIX	OXIDO	540 W	127 V~	50-60 Hz	E27	9
CFI12L/ONIX/O	CANDIL SUSPENDIDO	INTERIOR	ACERO FORJADO/ÓNIX	OXIDO	720 W	127 V~	50-60 Hz	E27	12

CFCP6L/O



CFS1261/O



CFD5L/CH



CÓDIGO	DESCRIPCIÓN	USO	MATERIA PRIMA	TERMINADO	POTENCIA MÁX (W)	VOLTAJE	VAC-Hz	TIPO DE SOCKET	# DE SOCKET
CFCP6L/O	CANDIL SUSPENDIDO	INTERIOR	ACERO FORJADO/ CRISTAL	OXIDO	360 W	127 V~	50-60 Hz	E27	6
CFS1261/O	CANDIL SUSPENDIDO	INTERIOR	ACERO FORJADO/ CRISTAL	OXIDO	120 W	127 V~	50-60 Hz	E27	2
CFD5L/CH	CANDIL SUSPENDIDO	INTERIOR	ACERO FORJADO/ CRISTAL	CHOCOLATE	300 W	127 V~	50-60 Hz	E27	5

CFT3LP/O

CFT6LP/O

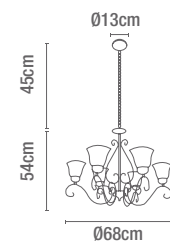
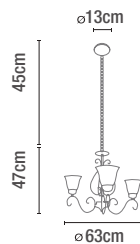

CÓDIGO	DESCRIPCIÓN	USO	MATERIA PRIMA	TERMINADO	POTENCIA MÁX (W)	VOLTAJE	VAC-Hz	TIPO DE SOCKET	# DE SOCKET
CFT3LP/O	CANDIL SUSPENDIDO	INTERIOR	ACERO FORJADO/ CRISTAL	OXIDO	180 W	127 V~	50-60 Hz	E27	3
CFT6LP/O	CANDIL SUSPENDIDO	INTERIOR	ACERO FORJADO/ CRISTAL	OXIDO	360 W	127 V~	50-60 Hz	E27	6

CFM3L/O

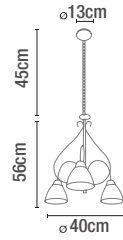

CFM5L/O

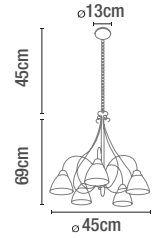

CFK5L/O

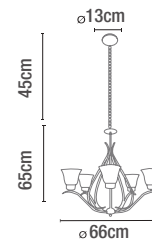

CÓDIGO	DESCRIPCIÓN	USO	MATERIA PRIMA	TERMINADO	POTENCIA MÁX (W)	VOLTAJE	VAC-Hz	TIPO DE SOCKET	# DE SOCKET
CFM3L/O	CANDIL SUSPENDIDO	INTERIOR	ACERO FORJADO/ CRISTAL	OXIDO	180 W	127 V~	50-60 Hz	E27	3
CFM5L/O	CANDIL SUSPENDIDO	INTERIOR	ACERO FORJADO/ CRISTAL	OXIDO	300 W	127 V~	50-60 Hz	E27	5
CFK5L/O	CANDIL SUSPENDIDO	INTERIOR	ACERO FORJADO/ CRISTAL	OXIDO	300 W	127 V~	50-60 Hz	E27	5



C2027-3/CO

C2025-5/CO

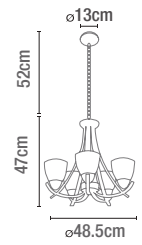
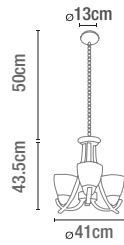

CÓDIGO	DESCRIPCIÓN	USO	MATERIA PRIMA	TERMINADO	POTENCIA MÁX (W)	VOLTAJE	VAC-Hz	TIPO DE SOCKET	# DE SOCKET
C2027-3/CO	CANDIL SUSPENDIDO	INTERIOR	ACERO FORJADO/ CRISTAL	CAFÉ OSCURO	180 W	127 V~	50-60 Hz	E27	3
C2025-5/CO	CANDIL SUSPENDIDO	INTERIOR	ACERO FORJADO/ CRISTAL	CAFÉ OSCURO	300 W	127 V~	50-60 Hz	E27	5

C1084-5



C1083-3



C1086-3+6

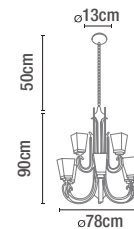
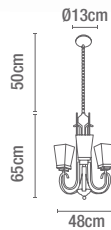
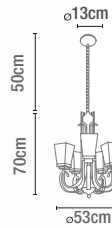

CÓDIGO	DESCRIPCIÓN	USO	MATERIA PRIMA	TERMINADO	POTENCIA MÁX (W)	VOLTAJE	VAC-Hz	TIPO DE SOCKET	# DE SHOCKET
C1083-3	CANDIL SUSPENDIDO	INTERIOR	ACERO FORJADO/ CRISTAL	VERDE ANTIGÜO	180 W	127 V~	50-60 Hz	E27	3
C1084-5	CANDIL SUSPENDIDO	INTERIOR	ACERO FORJADO/ CRISTAL	VERDE ANTIGÜO	300 W	127 V~	50-60 Hz	E27	5
C1086-3+6	CANDIL SUSPENDIDO	INTERIOR	ACERO FORJADO/ CRISTAL	VERDE ANTIGÜO	540 W	127 V~	50-60 Hz	E27	9

CIT3L/S



98133-3



C2027-3/S



C2025-5/S



CÓDIGO	DESCRIPCIÓN	USO	MATERIA PRIMA	TERMINADO	POTENCIA MÁX (W)	VOLTAJE	VAC-Hz	TIPO DE SOCKET	# DE SOCKET
CIT3L/S	CANDIL SUSPENDIDO	INTERIOR	ACERO/CRISTAL	SATINADO	180 W	127 V~	50-60 Hz	E27	3
98133-3	CANDIL SUSPENDIDO	INTERIOR	ACERO/CRISTAL	SATINADO	180 W	127 V~	50-60 Hz	E27	3
C2027-3/S	CANDIL SUSPENDIDO	INTERIOR	ACERO/CRISTAL	SATINADO	180 W	127 V~	50-60 Hz	E27	3
C2025-5/S	CANDIL SUSPENDIDO	INTERIOR	ACERO/CRISTAL	SATINADO	300 W	127 V~	50-60 Hz	E27	5

94933-3



2531-3

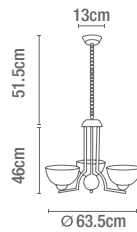

94938-5+3

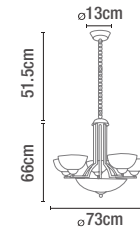
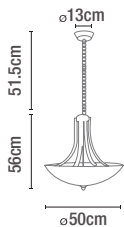

CÓDIGO	DESCRIPCIÓN	USO	MATERIA PRIMA	TERMINADO	POTENCIA MÁX (W)	VOLTAJE	VAC-Hz	TIPO DE SOCKET	# DE SOCKET
2531-3	CANDIL SUSPENDIDO	INTERIOR	ACERO/CRISTAL	SATINADO	180 W	127 V~	50-60 Hz	E27	3
94933-3	CANDIL SUSPENDIDO	INTERIOR	ACERO/CRISTAL	SATINADO	180 W	127 V~	50-60 Hz	E27	3
94938-5+3	CANDIL SUSPENDIDO	INTERIOR	ACERO/CRISTAL	SATINADO	480 W	127 V~	50-60 Hz	E27	8

96235-5



96233-3

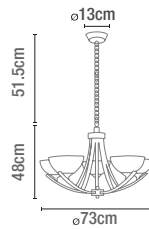

96239-3+6

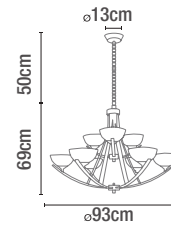
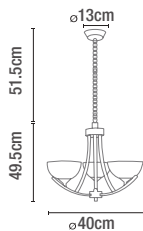

CÓDIGO	DESCRIPCIÓN	USO	MATERIA PRIMA	TERMINADO	POTENCIA MÁX (W)	VOLTAJE	VAC-Hz	TIPO DE SOCKET	# DE SOCKET
96233-3	CANDIL SUSPENDIDO	INTERIOR	ACERO/CRISTAL	SATINADO	180 W	127 V~	50-60 Hz	E27	3
96235-5	CANDIL SUSPENDIDO	INTERIOR	ACERO/CRISTAL	SATINADO	300 W	127 V~	50-60 Hz	E27	5
96239-3+6	CANDIL SUSPENDIDO	INTERIOR	ACERO/CRISTAL	SATINADO	540 W	127 V~	50-60 Hz	E27	9





FUNDICIÓN DE ALUMINIO Y POSTES

Diseña un exterior alegre y llamativo

CALUX
ILUMINA MEJOR

1501N



Hecho en México

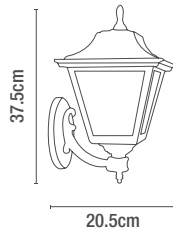

1503N



Hecho en México

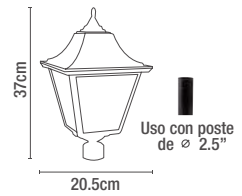

1601N



Hecho en México

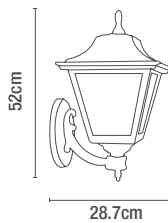

1603N



Hecho en México

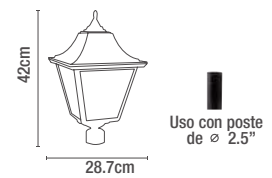

CÓDIGO	DESCRIPCIÓN	USO	MATERIA PRIMA	TERMINADO	POTENCIA MÁX (W)	VOLTAJE	VAC-Hz	IP	TIPO DE SOCKET	# DE SOCKET
1501N	LUMINARIO FAROL	EXTERIOR	ALUMINIO/CRISTAL	NEGRO	60 W	125 V~	50-60 Hz	54	E27	1
1503N	LUMINARIO FAROL	EXTERIOR	ALUMINIO/CRISTAL	NEGRO	60 W	125 V~	50-60 Hz	54	E27	1
1601N	LUMINARIO FAROL	EXTERIOR	ALUMINIO/CRISTAL	NEGRO	60 W	125 V~	50-60 Hz	54	E27	1
1603N	LUMINARIO FAROL	EXTERIOR	ALUMINIO/CRISTAL	NEGRO	60 W	125 V~	50-60 Hz	54	E27	1

1700N



Hecho en México



PE1700N



Hecho en México



PE1702N



Hecho en México



PE1705N



Hecho en México

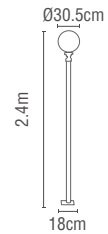

PPG/N



Hecho en México

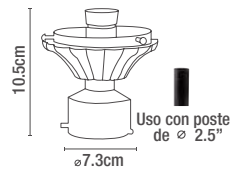

DRA/N



Hecho en México

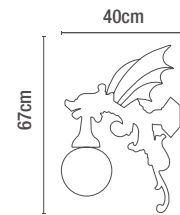

CÓDIGO	DESCRIPCIÓN	USO	MATERIA PRIMA	TERMINADO	POTENCIA MAX (W)	VOLTAJE	VAC-Hz	IP	TIPO DE SOCKET	# DE SOCKET
1700 N	POSTE FAROL CON CABEZAL Y BASE	EXTERIOR	POSTE ACERO FAROL ALUMINIO/CRISTAL	NEGRO	60 W	125 V~	50-60 Hz	54	E27	1
PE1700N	POSTE FAROL CON CABEZAL Y PLACA	EXTERIOR	POSTE ACERO FAROL ALUMINIO/CRISTAL	NEGRO	60 W	125 V~	50-60 Hz	54	E27	1
PE1702N	POSTE FAROL CON CABEZAL Y PLACA	EXTERIOR	POSTE ACERO FAROL ALUMINIO/CRISTAL	NEGRO	240 W	125 V~	50-60 Hz	54	E27	3
PE1705N	POSTE CON GLOBO OPALINO Y PLACA	EXTERIOR	POSTE ACERO FAROL ALUMINIO/CRISTAL OPALINO R12	NEGRO	60 W	125 V~	50-60 Hz	54	E27	1
PPG/N	PUNTA DE TUBO / BASE PARA GLOBO R8 Y R10 "	EXTERIOR	ALUMINIO	NEGRO	60 W	125 V~	50-60 Hz	54	E27	1
DRA/N	DRAGON CON GLOBO	EXTERIOR	ALUMINIO FUNDIDO/ CRISTAL OPALINO	NEGRO	60 W	125 V~	50-60 Hz	54	E27	1





CRISTAL OPALINO

Fusiona lo tradicional para alumbrar tu presente

CALUX
ILUMINA MEJOR

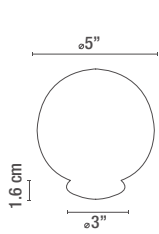

R5C/C



R6C/C

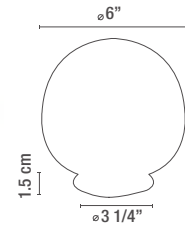

R8C/C

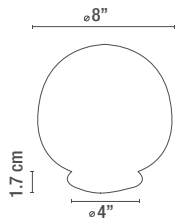

R10C/C

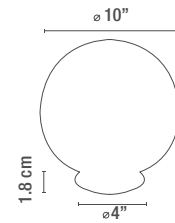

R12C/C4"

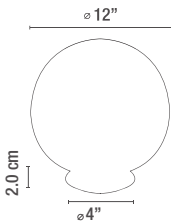

R12C/C6"

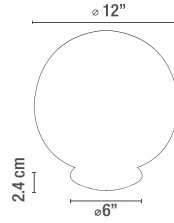

R14C/C6"

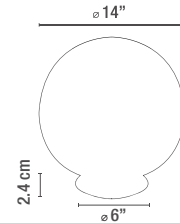

Hecho en México

CÓDIGO	DESCRIPCIÓN	USO	MATERIA PRIMA	TERMINADO
R5C/C	GLOBO 5" CRISTAL OPALINO	EXTERIOR	CRISTAL OPALINO	BLANCO
R6C/C	GLOBO 6" CRISTAL OPALINO	EXTERIOR	CRISTAL OPALINO	BLANCO
R8C/C	GLOBO 8" CRISTAL OPALINO	EXTERIOR	CRISTAL OPALINO	BLANCO
R10C/C	GLOBO 10" CRISTAL OPALINO	EXTERIOR	CRISTAL OPALINO	BLANCO
R12C/C4"	GLOBO 12" CRISTAL OPALINO	EXTERIOR	CRISTAL OPALINO	BLANCO
R12C/C6"	GLOBO 12" CRISTAL OPALINO	EXTERIOR	CRISTAL OPALINO	BLANCO
R14C/C6"	GLOBO 14" CRISTAL OPALINO	EXTERIOR	CRISTAL OPALINO	BLANCO

R714

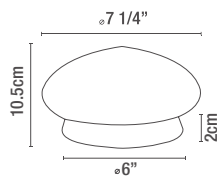

SCH6

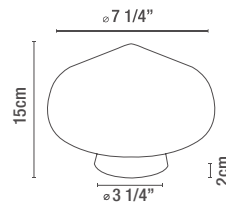

SCH8

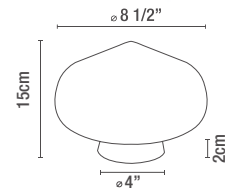

R634

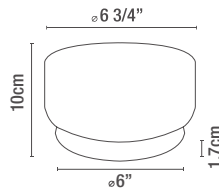

R15A

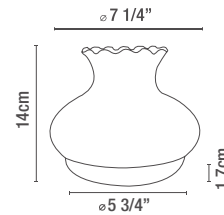

CÓDIGO	DESCRIPCIÓN	USO	MATERIA PRIMA	TERMINADO
R714	CRISTAL ASPIRINA	INTERIOR	CRISTAL OPALINO	BLANCO
SCH6	CRISTAL SCHOOL	INTERIOR	CRISTAL OPALINO	BLANCO
SCH8	CRISTAL SCHOOL	INTERIOR	CRISTAL OPALINO	BLANCO
R634	CRISTAL ASPIRINA	INTERIOR	CRISTAL OPALINO	BLANCO
R15A	CRISTAL QUINQUE	INTERIOR	CRISTAL OPALINO	BLANCO

CÓDIGO	PÁGINA
3112	127
3180	115
3190	115
4100	127
4101	127
4542	101
4544	103
5463	88
5471	91
5481	93
6280	114
6300	104
6501	102
6502	101
6504	103
6512	101
7040	102
7280	115
7371	116
7372	116
7450	116
8101	113
8102	113
8112	114
8143	109
8144	109
8145	109
8146	110
8148	110
8362	98
8382	99
96291	120
0120-LED	8
0120-LED/AZ	8
0220-LED	8
0720-LED	25
0860-LED/GR	29
0861-LED/GF	29
0920-LED/GF	25
1020-LED/GF	33
1025-LED/GF	45
1026-LED/GF	56

CÓDIGO	PÁGINA
1027-LED/BL	56
1028-LED/BL	56
1120-LED/GF	34
1120-LED/GR	34
1220-LED/GF	35
1220-LED/GR	35
1420-LED/GR	34
1501N	191
1503N	191
1520-LED/GR	35
1601N	191
1603N	191
1620-LED/B	37
1620-LED/GF	37
1620-LED/GR	37
1700 N	192
1712-LED/GR	17
1720-LED/GR	38
2008-E27/GF	90
2009-E27/GF	90
2011-GU10/GF	97
2012-E27/GF	90
2013-GU10/GF	97
2220-LED	12
2520-LED	39
2520-LED/B	39
2531-3	187
2620-LED	39
2720-LED	46
2820-LED	41
2920-LED	42
3020-LED	26
3021-LED	26
3022-LED	44
3023-LED	43
3320-LED	14
3420-LED	14
3520-LED	13
3620-LED	13
3720-LED	13
3820-LED/GF	46
3920-LED/BL	55

CÓDIGO	PÁGINA
4020-LED/B	16
4020-LED/G	16
4021-LED/GR	9
4022-LED/GR	9
4023-LED/GR	10
4024-LED/GR	10
4120-LED/B	16
4120-LED/G	16
4230-LED/BL	17
4231-LED/GF	11
4232-LED/GF	11
4240-LED/BL	20
4320-LED	44
4420-LED	43
4520-LED	31
4550-LED/GF	49
4620-LED	31
4720-LED	18
4720-LED/BL	18
4721S-LED/BL	18
4721S-LED/GR	18
4820-LED	32
4920-LED	32
5001/B	87
5011/B	87
5011/N	87
5020-LED	24
5021/B	87
5021/N	87
5031/B	87
5031/N	87
5120-LED	24
5192/G	89
5192/N	89
5194/G	89
5194/N	89
5220-LED/GF	47
5225-LED/GF	48
5226-LED/GF	49
5320-LED/GF	47
5420-LED/GF	45
5461/GF	91

CÓDIGO	PÁGINA
5462/GF	88
5463	88
5464/GF	91
5466/GF	88
5468/GF	89
5471	91
5481	93
5481/BL	93
5482/BL	93
5482/GF	93
5491/GF	89
5520-LED	51
5620-LED	51
5720-LED/BL	57
5721-LED/BL	48
6041/N	102
6041/O	102
6042/GF	103
6042/NE	103
6042/O	103
6043/GF	103
6043/N	103
6043/O	103
7020-LED	22
7031-A	112
7032-A	112
7033-A	112
7120-LED	23
7320-LED	22
7420-LED	33
7610-GU10/BL	82
7615-GU10/BL	82
7635-GU10/GF	94
7720-LED	66
7812-LED/BL	60
7820-LED/BL	57
7920-LED	66
8103-450	113
8113-450	114
8120-LED	23
8320-LED/B	53
8320-LED/GF	53

CÓDIGO	PÁGINA
8320-LED/GR	53
8362	98
8382	99
8363-650	106
8372/GF	98
8373S-500/GF	104
8373S-E27/GF	100
8374S-E27/GF	100
8383-650	106
8420-LED/GF	53
8420-LED/GR	53
8520-LED	54
8521-LED	54
8620-LED/GF	37
8620-LED/GR	37
8720-LED/GF	52
8720-LED/GR	52
8820-LED	41
8920-LED/GR	20
9020-LED	12
9220-LED	21
9221-LED	21
9268-GU10/BL	95
9268-GU10/GF	95
9269-GU10/BL	99
9270-GU10/BL	96
9270-GU10/GF	96
9271-GU10/BL	94
9271-GU10/GF	94
9272-GU10/GF	96
9273-GU10/BL	99
9273-GU10/GF	99
9274-GU10/BL	96
9274-GU10/GF	96
9281-GU10/BL	95
9281-GU10/GF	95
9282-GU10/GF	94
9283-GU10/BL	94
9283-GU10/GF	94
9320-LED/GF	42
94933-3	187
94938-5+3	187

CÓDIGO	PÁGINA
94991/ONIX/O	122
9520-LED	38
9620-LED	52
96233-3	188
96235-5	188
96239-3+6	188
98133-3	186
A1081-1	122
A1082-2	122
A2028-1/CO	121
A2028-1/S	119
A2029-2/CO	121
A7732/1	135
AE714/B	138
AE714/N	138
AFK1L/O	121
AJB11-12	120
AM6B	129
AM6N	129
AS1L/CH	119
AS1L/S	119
B021	120
BC6/N	129
BL24	137
BL24-CH	137
BL24WH	137
BLED10W	64
BR6/B	138
BR6/N	138
C010/NE	146
C020/CO	146
C050/CA	145
C060/NE	166
C061/NE	166
C070/AB	150
C071/AB	151
C072/AB	150
C076/NE	169
C077/NE	155
C077/NE-3	155
C078/NE	170
C079/NE	168

CÓDIGO	PÁGINA
C080/NE	170
C081/NE	168
C082/NE	169
C083/NE	170
C084/NE	157
C090/HU	151
C091/AB	147
C091/HU	147
C092/CR	160
C093/C	144
C093/HU	144
C094/CR	144
C095/S	145
C097/CC	166
C1083-3	185
C1084-5	185
C1086-3+6	185
C111/CO	156
C2025-5/CO	184
C2025-5/S	186
C2027-3/CO	184
C2027-3/S	186
C2029-5/GR	158
C2030-8/NE	156
C2031-4/GR	158
C2035-3/CR	143
C2035-3/NE	143
C2036-10/NE	157
C210/CC	143
C214/AN	149
C215/OR	149
C217/ORM	151
C218/BL	152
C218/ORM	152
C219/BL	164
C219/NE	164
C220/BL	167
C220/BL-3	167
C221/BL	161
C222/BL	161
C223/NE	162
C224/AZ	165

CÓDIGO	PÁGINA
C224/RO	165
C224/VE	165
C225/BL	160
C226/BL	162
C226/NE	162
C227/BL	163
C227/NE	163
C228/CGR	147
C229/BL	161
C401/AM	174
C601/AM	172
C3C601/AM	172
C701MB/AM	175
C701MC/AM	175
C901MB/AM	174
CA0236-2-LED/SA	68
CCF023/ONIX	179
CFCP6L/O	181
CFD5L/CH	181
CFI12L/ONIX/O	180
CFI5L/ONIX/O	179
CFI9L/ONIX/O	180
CFK5L/O	183
CFM3L/O	183
CFM5L/O	183
CFS1261/O	181
CFT3LP/O	182
CFT6LP/O	182
CFW6L/ONIX/O	180
CGDR	176
CIT3L/S	186
CL-0236-5-LED/SA	69
CL-1064-5-LED/BL	68
CL-1100-1-LED/SA	64
CL-1200-1-LED/CR	65
CL-1202-2-LED/CR	65
CL-1203-3-LED/CR	64
CL-1204-LED/SA	65
CL-2000S-LED/BL	26
CL-3010-LED/BL	68
CL-3012-LED/NE	69
CL-3614-LED/BL	60

CÓDIGO	PÁGINA
CL-4000-LED/BL	55
CL-5353-8-LED/SA	69
CL-8000-LED/BL	58
CL-8001-LED/BL	58
CL-9000-LED/GF	59
CL-9001-LED/GF	59
CL-9002-LED/GF	59
DL002-7W/C	70
DL002-7W/F	70
DL003-10W/N	70
DL004-15W/N	70
DL006-6.5W/C	71
DL006-6.5W/F	71
DL006-6.5W/N	71
DL007-12W/N	73
DL007-18W/N	73
DL007-8W/N	73
DL008-12W/F	70
DLP032-12W	74
DLP035-12W/N	74
DLP036-18W	74
DLS009-3W/N	72
DLS010-6W/N	72
DLS011-9W/N	72
DLS012-12W/N	72
DLS014-18W/N	72
DRA/N	192
EM2010C-GU10/B	79
EM2010C-GU10/S	79
EM2015C-E27/B	80
EM2015C-E27/S	80
EM2015-E27/B	80
EM2015-E27/S	80
EM2020C-E27/B	79
EM2020C-E27/S	79
EM2020-E27/B	79
EM2020-E27/S	79
EM5080C-E27/B	79
EM5080C-E27/S	79
F1090/CR	125
F1091/CR	125
F1092/CR	125

CÓDIGO	PÁGINA
F1093-LED/CR	63
F1094-LED/CR	63
F1095-LED/SA	62
F2130-3W	62
F2140-3W	60
FA199W-E27/C	76
FA199W-E27/F	76
GAVE	176
GU10SMD5W/C	76
GU10SMD5W/F	76
GX538W-E27/C	76
GX538W-E27/F	76
H2010/B	81
H2010/S	81
H4010/B	81
H4010/S	81
H5001/BL	82
H5002/BL	82
H5010/B	81
H5010/S	81
HS-5013-3	142
HS-5015-1/BL	141
HS-5015-2/BL	141
HS-5015-3/BL	141
HS-5016-1	126
HS-5017-2	126
HS-5018-3	126
HS-5028-3	142
JB11-12	136
JB11-16	136
JB11-9	136
LY2010-GU10	84
LY2018-GU10	84
LY2019-GU10	84
MR16SMD5W/C	76
MR16SMD5W/F	76
N450B	138
N450S	138
N850B	138
N850S	138
NE350/B	138
NE350/S	138

CÓDIGO	PÁGINA
OXC120PQ/P	124
OXC200/P	123
OXC200PQ/B	123
OXC200PQ/P	123
OXC50/P	173
OXG212/P	124
OXG312/P	124
P45SMD4W/C	76
PE1700N	192
PE1702N	192
PE1705N	192
PIT/S	172
PL300-12W	67
PL500-LED/CR	67
PL501-2/GR	135
P145/CH	134
P185/CH	134
P611/CH	134
P811/CH	134
PPG/N	192
Q3020	75
Q3025	75
Q3043	75
R10C/C	195
R12C/C4"	195
R12C/C6"	195
R14C/C6"	195
R15A	196
R5C/C	195
R634	196
R6C/C	195
R714	196
R8C/C	195
RF-3522-LED	27
RF-3524-LED	27
RF-3526-LED	27
S4010-LED	28
S4030-LED	28
S4050-LED	28
S6061-LED	25
SCH6	196
SCH8	196

CÓDIGO	PÁGINA
SPMD/S	135
V2020	148
V2021	160
V2022	154
V2023	159
V2024	154
V2024/MAD	153
V2024/NEG	153
V2025	159
V2028	145
V2032	148
V2042	171
V2046/OR	147
V2050	148
V2054	152
V22154W/25	128
V22154W/35	128
V22154W/65	128
V2740	171
V2750	171
V5641/1C	173
VINDGD	176

ICONOGRAFÍA CALUX

Los iconos CALUX te permiten identificar las características de nuestros productos de manera más fácil y rápida para ayudarte en tu elección.



Garantía de 3 años en todos los productos de la línea LED.



Garantía de 1 año en todos nuestros productos excepción línea LED.

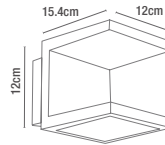

Medidas detalladas del producto.



Este ícono te indica cuando el producto ilumina hacia más de un lado.



Luminarias que encienden al detectar movimiento físico.



Identifica los productos de nuevo lanzamiento.



Productos mexicanos, apoyamos lo nacional.



Disfruta del beneficio adicional de poner a cargar tu celular gracias a la entrada USB que cuentan algunas de nuestras luminarias.



Te indica cuando una luminaria tiene tecnología luz solar por panel led.



Luminarias que emiten luz por reflexión.

CALUX se reserva el derecho de hacer modificaciones menores en los productos sin previo aviso. Las imágenes que se muestran en el catálogo son solo con fines ilustrativos. Se prohíbe la reproducción total o parcial de este catálogo por cualquier medio.

Visita nuestro sitio web y encuentra más información sobre nuestros productos, descarga fichas técnicas y fotometrías, entérate de los productos nuevos y mucho más.

www.calux.com.mx



calux



calux_ilumina

ILUMINACIÓN QUE CONECTA CON TU ESPACIO



CALUX
ILUMINA MEJOR

#mihogarc Lux



CALUX[®]
ILUMINA MEJOR

 calux

   calux_ilumina

www.calux.com.mx